

JUST

by ■ SPECTRAL



Collection 2024 / 2025

sideboards

4 – 17 just.juliet

18 – 31 just.charlie

32 – 39 just.lift

tv lowboards

40 – 47 just.alpha

48 – 57 just.bravo

58 – 65 just.lima

66 – 69 just.basic

70 – 73 just.delta

74 – 77 just.tango

78 – 85 just.office

86 – 88 just.rack

89 just.stand

90 – 91 just.mount

92 technical data

Symbol	Erklärung
Symbol	Explanation
Symbole	Explication
Simbolo	Spiegazione



Breite gesamt außen
Total external width
Largeur extérieure totale
Larghezza totale esterna



Höhe gesamt außen
Total external height
Hauteur extérieure totale
Altezza totale esterna



Tiefe gesamt außen
Total external depth
Profondeur extérieure totale
Profondità totale esterna

Symbol	Erklärung
Symbol	Explanation
Symbole	Explication
Simbolo	Spiegazione



Farbe der Oberfläche
Colour of the surface
Couleur de la surface
Colore della superficie

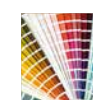

Es stehen über 2.000 Wunschfarben zur Wahl. Diese können nach NCS- oder Sikkens-5051-Farbfächer gewählt werden (RAL Farben auf Anfrage).

There are over 2,000 custom colours to choose from. This can be selected from the NCS or Sikkens 5051 colour chart (most RAL colours are available on request).

Plus de 2 000 couleurs personnalisées sont disponibles. Celles-ci figurent dans le nuancier NCS ou Sikkens-5051 (couleurs RAL sur demande).

È possibile scegliere tra oltre 2.000 colori. È possibile selezionarli in base alle collezioni colori NCS o Sikkens 5051 (colori RAL su richiesta).



Modelle mit diesem Symbol sind sofort ab Lager lieferbar.

Models with this symbol are immediately available from stock.

Les modèles portant ce symbole sont immédiatement disponibles depuis le stock.

I modelli con questo simbolo sono disponibili in pronta consegna.

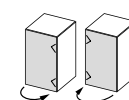

Türanschlag wählbar: links (wie dargestellt) oder rechts

Door hinge left (as shown) or right available

Charnière de porte au choix: gauche (comme illustré) ou droite

Cerniera anta a sinistra (come disegno) opzionale a destra

Symbol	Erklärung
Symbol	Explanation
Symbole	Explication
Simbolo	Spiegazione



Breite gesamt innen
Total inside width
Largeur intérieure totale
Larghezza totale interna



Höhe gesamt innen
Total height inside
Hauteur intérieure totale
Altezza totale interna



Tiefe gesamt innen
Total inside depth
Profondeur intérieure totale
Profondità totale interna

Symbol	Erklärung
Symbol	Explanation
Symbole	Explication
Simbolo	Spiegazione



Höhenverstellung der Füße möglich
Height adjustment of the feet possible
Réglage de la hauteur des pieds possible
Possibilità di regolare l'altezza dei piedi



Möbel besteht aus 2 Teilen
Furniture consists of 2 parts
Le meuble se compose de 2 parties
Il mobile è composto da 2 parti



passend für Möbelbreite x – x
suitable for furniture width x – x
convient aux meubles largeur x – x
adatto per mobili con larghezza x – x

DT Drehtür
Door
Porte
Anta

KL Klappe
Flap
Abattant
Anta a ribalta

SL Schublade
Drawer
Tiroir
Cassetto



Drehbare TV-Halterung
Rotating TV mount
Support TV pivotant
Supporto TV girevole



▲ Just.Juliet JSJ2085, Push-to-Open, Granite / Marmor Black, Design feet One

◀ Just.Juliet JSJ0913, Pebble, Design feet Three

Jetzt einfach online konfigurieren
Simply configure online
www.justbyspectral.de





Mit Griff
With handle
Avec poignée
Con maniglia



Grifflos, Push-to-Open
Handleless, push-to-open
Sans poignées, push-to-open
Senza maniglia, push-to-open



Türen mit Soft-Close Dämpfung
Doors with soft-close damping
Portes avec amortissement soft-close
Porte con chiusura ammortizzata



Hochwertige Schubladen mit Softeinzug
High-quality drawers with soft-close mechanism
Tiroirs de haute qualité avec mécanisme soft-close
Chiusura ammortizzata dei cassetti



Stabile Holzeinlegeböden
Sturdy wooden shelves
Étagères en bois stables
Robusti ripiani in legno

LED-Hintergrundbeleuchtung
LED backlight
Rétroéclairage par LED
Retroilluminazione a LED



Modellvariante – Stauraum mit Drehtüren

Model variant – Storage space with doors

Variante du modèle – Espace de rangement avec portes

Variante del modello – vano portaoggetti con ante



Modellvariante – Schublade mit Klappe und Drehtüren

Model variant – drawer with flap and doors

Variante du modèle – tiroir avec abattant et portes

Variante del modello – cassetto con ribalta e ante



Fußgleiter

Foot glides
Patins
Sottopiedi



Wandmontage Kit

Wall mounting kit
Kit de montage mural
Kit per il montaggio a parete



Designfuß One

Design foot One
Pieds design One
Piedi design One



Designfuß Two

Design foot Two
Pieds design Two
Piedi design Two



Designfuß Three

Design foot Three
Pieds design Three
Piedi design Three

Alle Aufstellarten sind höhenverstellbar, Farbe Black

All installation types are height adjustable, colour Black
Tous les types d'installation sont réglables en hauteur, couleur Black
Tutti i tipi di installazione sono regolabili in altezza, colore Black



Just.Juliet JSJ2083, Granite / Marmor Grey, Design feet Three

Just.Juliet – Sideboards

Sideboards mit Schublade müssen an der Wand befestigt werden (Befestigungsmaterial wird mitgeliefert)
 Sideboards with drawer must be mounted to the wall (mounting kit is supplied)
 Les éléments avec tiroir doivent être fixés au mur (matériel de fixation fourni)
 I mobili con cassetto devono essere fissati alla parete (il materiale di fissaggio è in dotazione)



Tiefe gesamt außen 44,5cm
 Total external depth
 Profondeur extérieure totale
 Profondità totale esterna

1 2 Modell besteht aus zwei Korpusen, mittig geteilt
 Model consists of two bodies, divided in the middle |
 Le modèle se compose de deux armoires, divisées
 au milieu | Modello composto da due elementi, divisi
 al centro

SL = Schublade | Drawer | Tiroir | Cassetto
KL = Klappe | Flap | Abattant | Anta a ribalta
DT = Drehtür | Door | Porte | Anta

Bild | Image | Immagine

Außenmaße (cm) ohne Deckplatte, ohne Füße bzw. Fußgleiter

External dimensions [cm] without top plate, without feet or foot glides
 Dimensions extérieures [cm] sans plateau supérieur, sans pieds ni patins
 Dimensioni esterne [cm] senza top, senza piedini o guide per i piedi

Artikel
 Article
 Article
 Articolo

Funktion
 Function
 Fonction
 Funzione

Innenmaße (cm)
 Internal dimensions [cm] | Dimensions
 intérieures [cm] | Dimensioni int. [cm]

SL | KL | DT

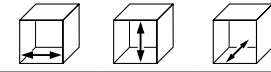

JSJ0452	a = DT	41,2	46,2	39,8
----------------	---------------	------	------	------

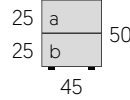

JSJ0453	a = SL	37,0	18,8	37,4
	b = KL	41,2	21,4	39,8

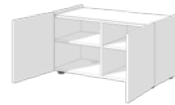
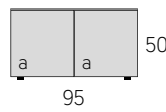

JSJ0952	a = DT	2x 44,6	46,2	39,8
----------------	---------------	---------	------	------

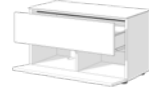
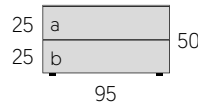

JSJ0953	a = SL	87,0	16,3	37,4
	b = KL	2x 44,6	21,4	39,8

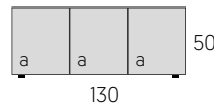

JSJ1352	a = DT	3x 40,8	46,2	39,8
----------------	---------------	---------	------	------

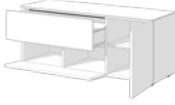
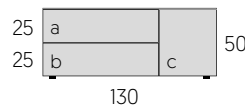

JSJ1353	a = SL	79,3	16,3	37,4
	b = KL	2x 40,8	21,4	39,8
	c = DT	40,8	46,2	39,8

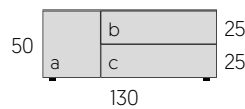

JSJ1355	a = DT	40,8	46,2	39,8
	b = SL	79,3	16,3	37,4
	c = KL	2x 40,8	21,4	39,8

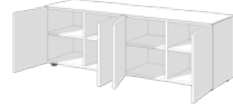
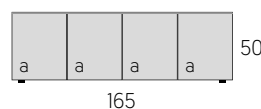

JSJ1652	a = DT	4x 38,8	46,2	39,8
----------------	---------------	---------	------	------

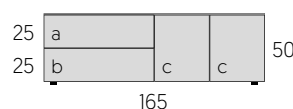

JSJ1653	a = SL	75,4	16,3	37,4
	b = KL	2x 38,8	21,4	39,8
	c = DT	2x 38,8	46,2	39,8

Just.Juliet – Sideboards

Bild | Image | Immagine

Außenmaße (cm) ohne Deckplatte, ohne Füße bzw. Fußgleiter

External dimensions [cm] without top plate, without feet or foot glides
 Dimensions extérieures [cm] sans plateau supérieur, sans pieds ni patins
 Dimensioni esterne [cm] senza top, senza piedini o guide per i piedi

Artikel
 Article
 Article
 Articolo

Funktion
 Function
 Fonction
 Funzione

Innenmaße (cm)
 Internal dimensions [cm] | Dimensions
 intérieures [cm] | Dimensioni int. [cm]

SL | KL | DT

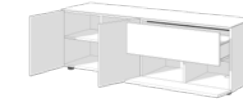
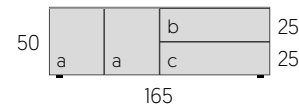
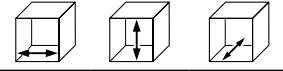

JSJ1655	a = DT	2x 38,8	46,2	39,8
	b = SL	75,4	16,3	37,4
	c = KL	2x 38,8	21,4	39,8

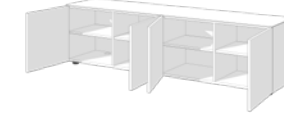
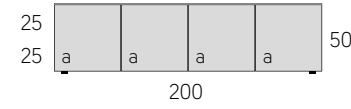

JSJ2052	a = DT	4x 47,6	46,2	39,8
----------------	---------------	---------	------	------

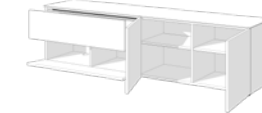
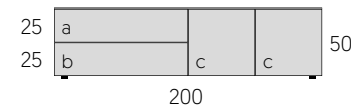

JSJ2053	a = SL	92,9	16,3	37,4
	b = KL	2x 47,6	21,4	39,8
	c = DT	2x 47,6	46,2	39,8

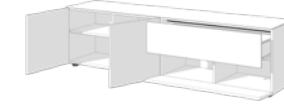
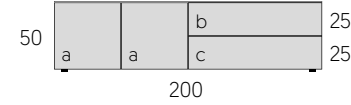

JSJ2055	a = DT	2x 47,6	46,2	39,8
	b = SL	92,9	16,3	37,4
	c = KL	2x 47,6	21,4	39,8

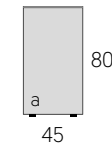

JSJ0482	a = DT	41,2	76,2	39,8
----------------	---------------	------	------	------

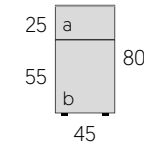

JSJ0483	a = SL	37,0	18,8	37,4
	b = DT	41,2	51,4	39,8

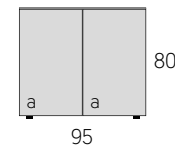

JSJ0982	a = DT	2x 44,6	76,2	39,8
----------------	---------------	---------	------	------

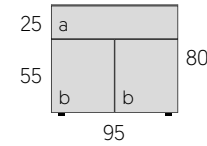

JSJ0983	a = SL	87,0	16,3	37,4
	b = DT	2x 44,6	51,4	39,8

Just.Juliet – Sideboards

Bild | Image | Image | Immagine

Außenmaße [cm] ohne Deckplatte, ohne Füße bzw. Fußgleiter

External dimensions [cm] without top plate, without feet or foot glides
Dimensions extérieures [cm] sans plateau supérieur, sans pieds ni patins
Dimensioni esterne [cm] senza top, senza piedini o guide per i piedi

Artikel
Article
Articolo

Funktion
Function
Fonction
Funzione

SL | KL | DT

Innenmaße [cm]
Internal dimensions [cm] | Dimensions
intérieures [cm] | Dimensioni int. [cm]

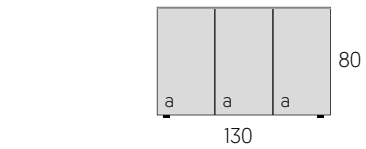
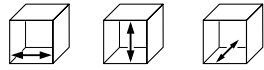

JSJ1382	a = DT	3x 40,8	76,2	39,8
----------------	---------------	---------	------	------

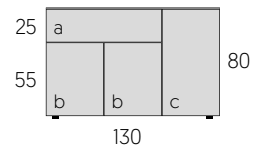

JSJ1383	a = SL	79,3	16,3	37,4
	b = DT	2x 40,8	51,4	39,8
	c = DT	40,8	76,2	39,8

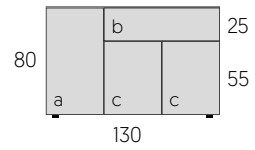

JSJ1385	a = DT	40,8	76,2	39,8
	b = SL	79,3	16,3	37,4
	c = DT	40,8	51,4	39,8

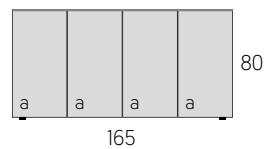

JSJ1682	a = DT	4x 38,8	76,2	39,8
----------------	---------------	---------	------	------

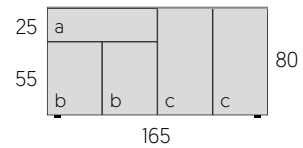

JSJ1683	a = SL	75,4	16,3	37,4
	b = DT	2x 38,8	51,4	39,8
	c = DT	2x 38,8	76,2	39,8

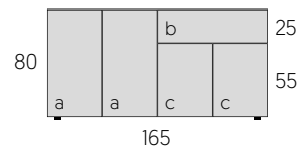

JSJ1685	a = DT	2x 38,8	76,2	39,8
	b = SL	75,4	16,3	37,4
	c = DT	2x 38,8	51,4	39,8

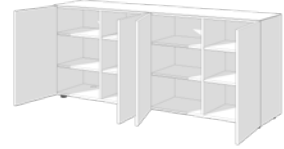
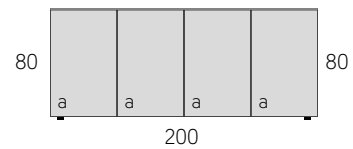

JSJ2082	a = DT	4x 47,1	76,2	39,8
----------------	---------------	---------	------	------

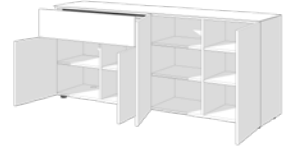
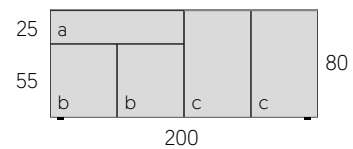

JSJ2083	a = SL	92,0	16,3	37,4
	b = DT	2x 47,1	51,4	39,8
	c = DT	2x 47,1	76,2	39,8

Just.Juliet – Sideboards

Bild | Image | Image | Immagine

Außenmaße [cm] ohne Deckplatte, ohne Füße bzw. Fußgleiter

External dimensions [cm] without top plate, without feet or foot glides
Dimensions extérieures [cm] sans plateau supérieur, sans pieds ni patins
Dimensioni esterne [cm] senza top, senza piedini o guide per i piedi

Artikel
Article
Articolo

Funktion
Function
Fonction
Funzione

SL | KL | DT

Innenmaße [cm]
Internal dimensions [cm] | Dimensions
intérieures [cm] | Dimensioni int. [cm]

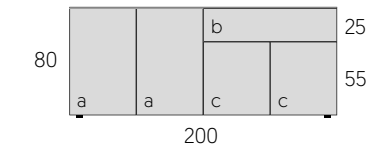
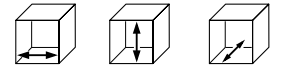

JSJ2085	a = DT	2x 47,1	76,2	39,8
	b = SL	92,0	16,3	37,4
	c = DT	2x 47,1	51,4	39,8

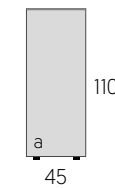

JSJ0412	a = DT	41,2	106,2	39,8
----------------	---------------	------	-------	------

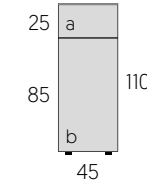

JSJ0413	a = SL	37,0	18,8	37,4
	b = DT	41,2	81,4	39,8

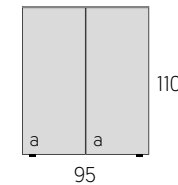

JSJ0912	a = DT	2x 44,6	106,2	39,8
----------------	---------------	---------	-------	------

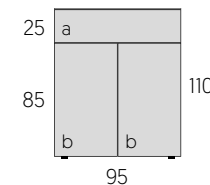

JSJ0913	a = SL	87,0	16,3	37,4
	b = DT	2x 44,6	81,4	39,8

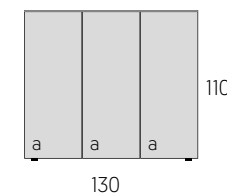

JSJ1312	a = DT	3x 40,8	106,2	39,8
----------------	---------------	---------	-------	------

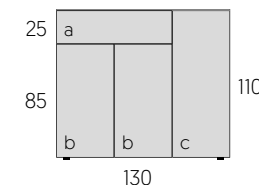

JSJ1313	a = SL	79,3	16,3	37,4
	b = DT	2x 40,8	81,4	39,8
	c = DT	40,8	106,2	39,8

Bild | Image | Image | Immagine

Außenmaße (cm) ohne Deckplatte, ohne Füße bzw. Fußgleiter

External dimensions (cm) without top plate, without feet or foot glides
Dimensions extérieures (cm) sans plateau supérieur, sans pieds ni patins
Dimensioni esterne (cm) senza top, senza piedini o guide per i piedi

Artikel

Article

Article

Articolo

Funktion

Function

Fonction

Funzione

SL | KL | DT

Innenmaße (cm)

Internal dimensions (cm) | Dimensions intérieures (cm) | Dimensioni int. (cm)

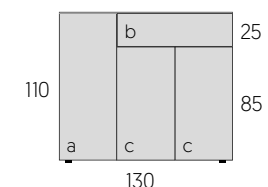
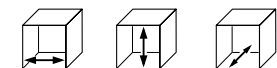

JSJ1315

a = DT	40,8	106,2	39,8
b = SL	79,3	16,3	37,4
c = DT	2x 40,8	81,4	39,8

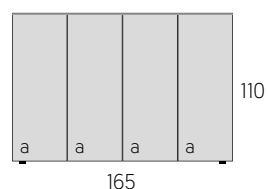

JSJ1612

a = DT	4x 38,4	106,2	39,8
---------------	---------	-------	------

1 2

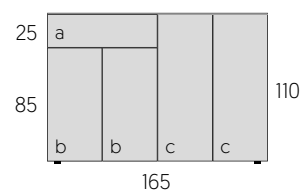

JSJ1613

a = SL	74,5	16,3	37,4
b = DT	2x 38,4	81,4	39,8
c = DT	2x 38,4	106,2	39,8

1 2

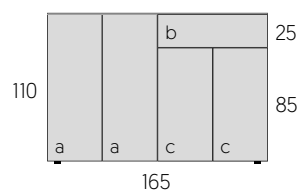

JSJ1615

a = DT	2x 38,4	106,2	39,8
b = SL	74,5	16,3	37,4
c = DT	2x 38,4	81,4	39,8

1 2

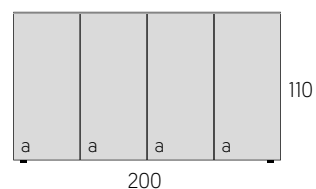

JSJ2012

a = DT	4x 47,1	106,2	39,8
---------------	---------	-------	------

1 2

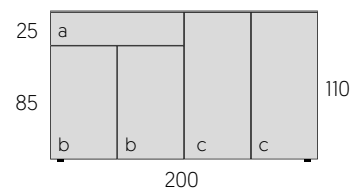

JSJ2013

a = SL	92,0	16,3	37,4
b = DT	2x 47,1	81,4	39,8
c = DT	2x 47,1	106,2	39,8

1 2

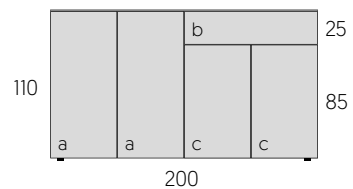

JSJ2015

a = DT	2x 47,1	106,2	39,8
b = SL	92,0	16,3	37,4
c = DT	2x 47,1	81,4	39,8

1 2

Options and accessories | Options et accessoires | Opzioni e accessori

Bild

Image

Image

Immagine



Artikel

Article

Article

Articolo

Beschreibung

Description

Description

Descrizione

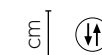

Aufstellarten | Installation types | Types d'installation | Sistema di montaggio

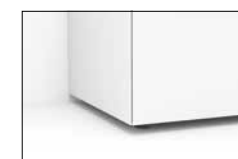

Standard

Fußgleiter, ohne Aufpreis
Foot glides, without surcharge | Patins, sans supplément de prix | Sottopiedi, senza sovrapprezzo 2,5 +1,0



JSZ01

Design foot One, Set mit 5 Stück für Möbelbreite 130 – 200 cm
Set of 5 pieces for furniture width 130 – 200 cm | Set de 5 pièces pour meubles largeur 130 – 200 cm | Set di 5 pezzi per mobili con larghezza 130 – 200 cm 13,0 +0,5



JSZ01-4

Design foot One, Set mit 4 Stück für Möbelbreite 45 – 95 cm
Set of 4 pieces for furniture width 45 – 95 cm | Set de 4 pièces pour meubles largeur 45 – 95 cm | Set di 4 pezzi per mobili con larghezza 45 – 95 cm 13,0 +0,5



JSZ02

Design foot Two, Set mit 5 Stück für Möbelbreite 130 – 200 cm
Set of 5 pieces for furniture width 130 – 200 cm | Set de 5 pièces pour meubles largeur 130 – 200 cm | Set di 5 pezzi per mobili con larghezza 130 – 200 cm 13,0 +0,5



JSZ02-4

Design foot Two, Set mit 4 Stück für Möbelbreite 45 – 95 cm
Set of 4 pieces for furniture width 45 – 95 cm | Set de 4 pièces pour meubles largeur 45 – 95 cm | Set di 4 pezzi per mobili con larghezza 45 – 95 cm 13,0 +0,5

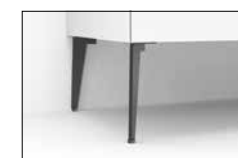

JSZ03

Design foot Three, Set mit 5 Stück für Möbelbreite 130 – 200 cm
Set of 5 pieces for furniture width 130 – 200 cm | Set de 5 pièces pour meubles largeur 130 – 200 cm | Set di 5 pezzi per mobili con larghezza 130 – 200 cm 23,0 +0,5



JSZ03-4

Design foot Three, Set mit 4 Stück für Möbelbreite 45 – 95 cm
Set of 4 pieces for furniture width 45 – 95 cm | Set de 4 pièces pour meubles largeur 45 – 95 cm | Set di 4 pezzi per mobili con larghezza 45 – 95 cm 23,0 +0,5



JSZ08

Wandmontage Kit für Möbelbreite 130 – 200 cm
Wall mounting kit for furniture width 130 – 200 cm | Kit de montage mural pour meubles largeur 130 – 200 cm | Kit per il montaggio a parete per mobili con larghezza 130 – 200 cm



JSZ08-2

Wandmontage Kit für Möbelbreite 45 – 95 cm
Wall mounting kit for furniture width 45 – 95 cm | Kit de montage mural pour meubles largeur 45 – 95 cm | Kit per il montaggio a parete per mobili con larghezza 45 – 95 cm



Option

Frontöffnung wahlweise grifflos (Push-to-Open) oder mit Griff (schwarz)
Front opening handle-free (push-to-open) or with handle (black) available
Ouverture frontale disponible sans poignée (push-to-open) ou avec poignée (noire)
Apertura frontale a scelta senza maniglia (push-to-open) o con maniglia (nera)



Option

Deckplatte wahlweise Colour Glas glänzend/satiniert (4 mm), Design Glas glänzend (4 mm) oder Holzdekor (12 mm)
Top plate in Colour glass glossy/satin (4 mm), Design glass glossy (4 mm) or wood decor (12 mm) available
Plateau supérieur en verre coloré brillant/satiné (4 mm), verre design brillant (4 mm) ou décor en bois (12 mm) disponible
Top in vetro colorato lucido/satinato (4 mm), vetro di design lucido (4 mm) o decoro legno (12 mm) disponibile



JSZ20

LED-Beleuchtung, warmweiß, dimmbar, inklusive Fernbedienung

LED lighting, warm white, dimmable, remote control included
Éclairage LED, blanc chaud, intensité lumineuse variable, télécommande incluse
Illuminazione LED, colore bianco caldo, dimmerabile, incluso telecomando

Just.Juliet – colours & surfaces

Colours & surfaces | Couleurs & surfaces | Colori & superfici

Möbelfarben für Sideboards

Furniture colours for sideboards | Couleurs de meubles pour sideboards | Colori dei mobili per credenze

Uni Farben – pflegeleichte, matte Oberfläche (19 mm)

Plain colours – easy-care, matt surface (19 mm) | Couleurs unies – surface finition mate facile à entretenir (19 mm) |

Colori tinta unita – superficie opaca di facile manutenzione (19 mm)

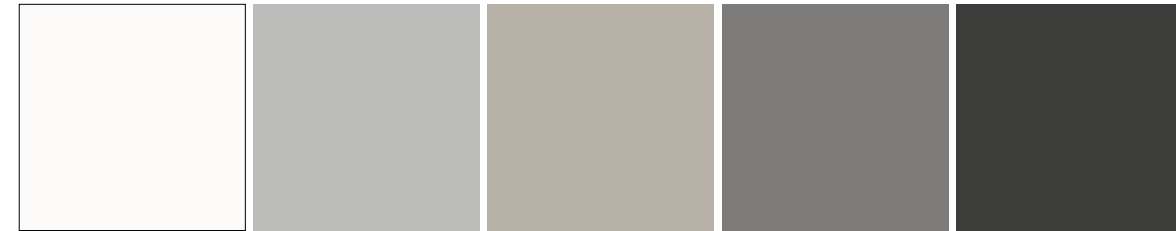

SNG Snow

GR Grey

PE Pebble

GN Granite

BG Black

Oberflächen für Deckplatten

Surfaces for top plates | Surfaces pour plateaux supérieures | Superfici per top

Colour Glas – glänzend oder satiniert (4 mm)

Colour glass – glossy or satin (4 mm) | Verre coloré – brillant ou satiné (4 mm) | Vetro colorato – lucido o satinato (4 mm)

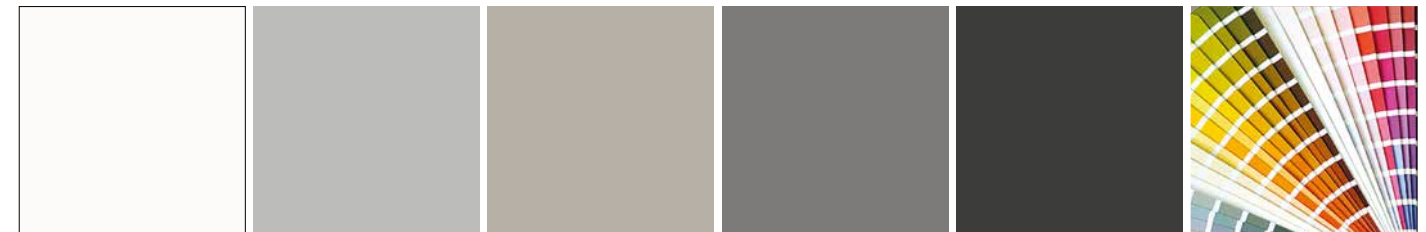

SNG Snow

GR Grey

PE Pebble

GN Granite

BG Black

NCS®/Sikkens 5051

Design Glas – glänzend (4 mm)

Design glass – glossy (4 mm)

Verre design – brillant (4 mm)

Vetro di design – lucido (4 mm)



DG100 Marmor Black

DG101 Marmor White

DG102 Marmor Grey

Holzdekor – strukturiert (12 mm)

Wood decor – textured (12 mm)

Décor en bois – structuré (12 mm)

Decoro in legno – strutturato (12 mm)



LO Light Oak

DP Deep Oak

Belastungsangaben & Technische Daten

Load & technical data | Charge et caractéristiques techniques | Indicazioni di carico & dati tecnici



92



▲ Just.Charlie JSC2055, Granite / Marmor Black, Design feet One

◀ Just.Charlie JSC1613, Granite / Marmor Grey, Foot glides

Jetzt einfach online konfigurieren
Simply configure online
www.justbyspectral.de





Türen mit Soft-Close Dämpfung
 Doors with soft-close damping
 Portes avec amortissement soft-close
 Porte con chiusura ammortizzata

Flachcharniere und gedämpfte Klappen
 Flat hinges and damped flaps
 Charnières plates et abattants avec système
 d'amortissement
 Cerniere piatte e sportelli ammortizzati



Hochwertige Schubladen mit Softeinzug
 High-quality drawers with
 soft-close mechanism
 Tiroirs de haute qualité avec
 mécanisme soft-close
 Chiusura ammortizzata dei cassetti

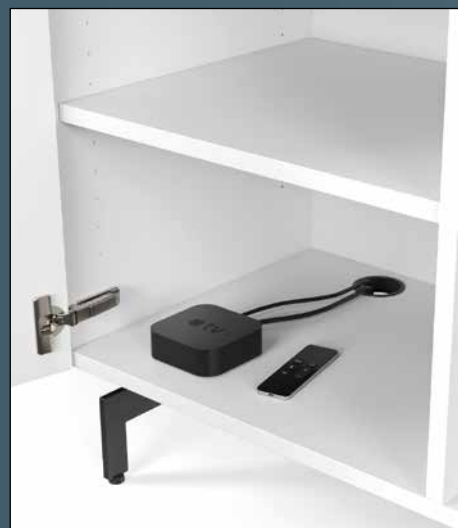

Kabelöffnung im Boden
 Cable opening in the bottom
 Ouverture pour le câble dans le fond
 Apertura per cavi nel fondo



Stabile Holzeinlegeböden
 Sturdy wooden shelves
 Étagères en bois stables
 Robusti ripiani in legno

LED-Hintergrundbeleuchtung
 LED backlight
 Rétroéclairage par LED
 Retroilluminazione a LED



Modellvariante – Stauraum mit Drehtüren

Model variant – Storage space with doors

Variante du modèle – Espace de rangement avec portes

Variante del modello – vano portaoggetti con ante



Modellvariante – Schublade mit Klappe und Drehtüren

Model variant – drawer with flap and doors

Variante du modèle – tiroir avec abattant et portes

Variante del modello – cassetto con ribalta e ante

Just.Charlie – Setup



Fußgleiter

Foot glides
Patins
Sottopiedi



Wandmontage Kit

Wall mounting kit
Kit de montage mural
Kit per il montaggio a parete



Designfuß One

Design foot One
Pieds design One
Piedi design One



Designfuß Two

Design foot Two
Pieds design Two
Piedi design Two



Designfuß Three

Design foot Three
Pieds design Three
Piedi design Three

Alle Aufstellarten sind höhenverstellbar, Farbe Black

All installation types are height adjustable, colour Black
Tous les types d'installation sont réglables en hauteur, couleur Black
Tutti i tipi di installazione sono regolabili in altezza, colore Black



Just.Charlie JSC2083, Pebble / Marmor Grey, Design feet Three

Just.Charlie – Sideboards

Sideboards mit Schublade müssen an der Wand befestigt werden (Befestigungsmaterial wird mitgeliefert)
 Sideboards with drawer must be mounted to the wall (mounting kit is supplied)
 Les éléments avec tiroir doivent être fixés au mur (matériel de fixation fourni)
 I mobili con cassetto devono essere fissati alla parete (il materiale di fissaggio è in dotazione)



Tiefe gesamt außen 46,7 cm
 Total external depth
 Profondeur extérieure totale
 Profondità totale esterna

1 2 Modell besteht aus zwei Korpusen, mittig geteilt
 Model consists of two bodies, divided in the middle |
 Le modèle se compose de deux armoires, divisées
 au milieu | Modello composto da due elementi, divisi
 al centro

SL = Schublade | Drawer | Tiroir | Cassetto
KL = Klappe | Flap | Abattant | Anta a ribalta
DT = Drehtür | Door | Porte | Anta

Bild | Image | Immagine
Außenmaße (cm) ohne Füße bzw. Fußgleiter
 External dimensions (cm) without feet or foot glides
 Dimensions extérieures (cm) sans pieds ni patins
 Dimensioni esterne (cm) senza piedini o guide per i piedi

Artikel
 Article
 Articolo
Funktion
 Function
 Fonction
 Funzione
Innenmaße (cm)
 Internal dimensions (cm) | Dimensions
 intérieures (cm) | Dimensioni int. (cm)
SL | KL | DT



JSC0452	a = DT	45,2	43,7	42,0
----------------	---------------	------	------	------

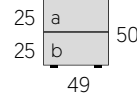

JSC0453	a = SL	41,0	16,2	37,4
	b = KL	45,2	21,4	42,0

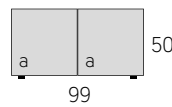

JSC0952	a = DT	2x 46,6	43,7	42,0
----------------	---------------	---------	------	------

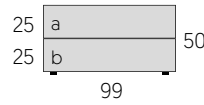

JSC0953	a = SL	91,0	16,2	37,4
	b = KL	2x 46,6	21,4	42,0

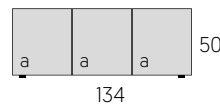

JS1352	a = DT	3x 42,1	43,7	42,0
---------------	---------------	---------	------	------

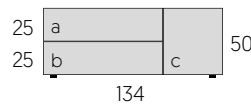

JSC1353	a = SL	81,9	16,2	37,4
	b = KL	2x 42,1	21,4	42,0
	c = DT	42,1	43,7	42,0

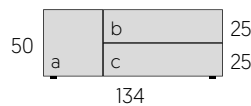

JSC1355	a = DT	42,1	43,7	42,0
	b = SL	81,9	16,2	37,4
	c = KL	2x 42,1	21,4	42,0

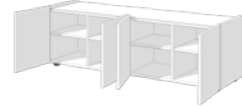
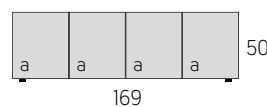

JSC1652	a = DT	4x 39,8	43,7	42,0
----------------	---------------	---------	------	------

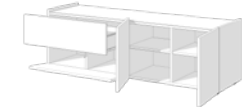
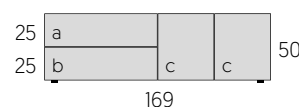

JSC1653	a = SL	77,4	16,2	37,4
	b = KL	2x 39,8	21,4	42,0
	c = DT	2x 39,8	43,7	42,0

Just.Charlie – Sideboards

Bild | Image | Immagine
Außenmaße (cm) ohne Füße bzw. Fußgleiter
 External dimensions (cm) without feet or foot glides
 Dimensions extérieures (cm) sans pieds ni patins
 Dimensioni esterne (cm) senza piedini o guide per i piedi

Artikel
 Article
 Articolo
Funktion
 Function
 Fonction
 Funzione
SL | KL | DT

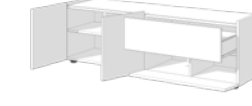
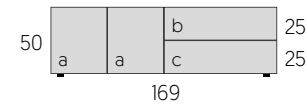
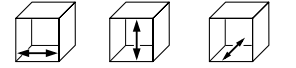

JSC1655	a = DT	2x 39,8	43,7	42,0
	b = SL	77,4	16,2	37,4
	c = KL	2x 39,8	21,4	42,0

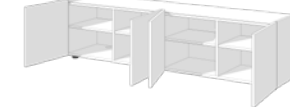
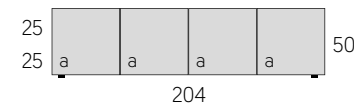

JSC2052	a = DT	4x 48,6	43,7	42,0
----------------	---------------	---------	------	------

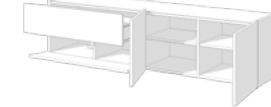
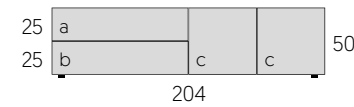

JSC2053	a = SL	94,9	16,2	37,4
	b = KL	2x 48,6	21,4	42,0
	c = DT	2x 48,6	43,7	42,0

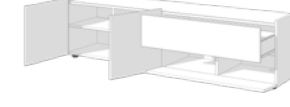
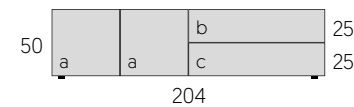

JSC2055	a = DT	2x 48,6	43,7	42,0
	b = SL	94,9	16,2	37,4
	c = KL	2x 48,6	21,4	42,0

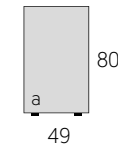

JSC0482	a = DT	45,2	73,7	42,0
----------------	---------------	------	------	------

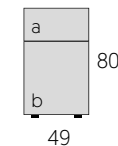

JSC0483	a = SL	41,0	16,2	37,4
	b = DT	45,2	51,4	42,0

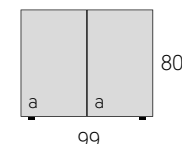

JSC0982	a = DT	2x 46,6	73,7	42,0
----------------	---------------	---------	------	------

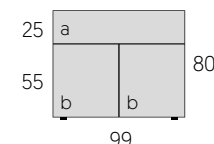

JSC0983	a = SL	91,0	16,2	37,4
	b = DT	2x 46,6	51,4	42,0

Just.Charlie – Sideboards

Bild | Image | Image | Immagine
Außenmaße (cm) ohne Füße bzw. Fußgleiter
 External dimensions (cm) without feet or foot glides
 Dimensions extérieures (cm) sans pieds ni patins
 Dimensioni esterne (cm) senza piedini o guide per i piedi









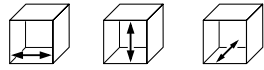

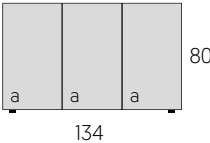

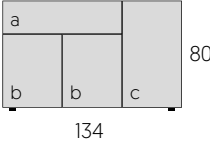

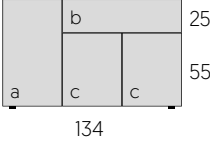

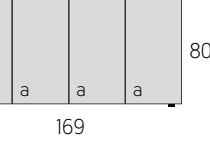
Artikel
 Article
 Article
 Articolo

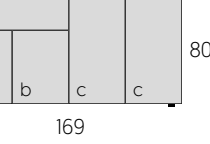
Funktion
 Function
 Fonction
 Funzione

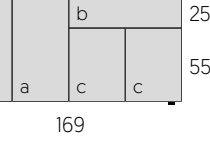
Innenmaße (cm)
 Internal dimensions (cm) | Dimensions intérieures (cm) | Dimensioni int. (cm)

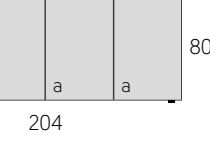
SL | KL | DT



		JSC1382	a = DT	3x 42,1	73,7	42,0
		JSC1383	a = SL b = DT c = DT	81,9 2x 42,1 42,1	16,2 51,4 73,7	37,4 42,0 42,0
		JSC1385	a = DT b = SL c = DT	42,1 81,9 2x 42,1	73,7 16,2 51,4	42,0 37,4 42,0
		JSC1682	a = DT	4x 39,8	73,7	42,0
		JSC1683	a = SL b = DT c = DT	77,4 2x 39,8 2x 39,8	16,2 51,4 73,7	37,4 42,0 42,0
		JSC1685	a = DT b = SL c = DT	2x 39,8 77,4 2x 39,8	73,7 16,2 51,4	42,0 37,4 42,0
		JSC2082	a = DT	4x 48,1	73,7	42,0
		JSC2083	a = SL b = DT c = DT	94,0 2x 48,1 2x 48,1	16,2 51,4 73,7	37,4 42,0 42,0

Just.Charlie – Sideboards

Bild | Image | Image | Immagine
Außenmaße (cm) ohne Füße bzw. Fußgleiter
 External dimensions (cm) without feet or foot glides
 Dimensions extérieures (cm) sans pieds ni patins
 Dimensioni esterne (cm) senza piedini o guide per i piedi









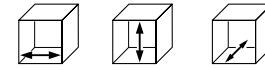

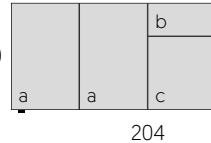

Artikel
 Article
 Article
 Articolo

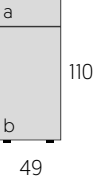
Funktion
 Function
 Fonction
 Funzione

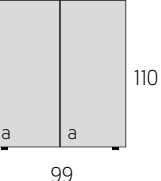
Innenmaße (cm)
 Internal dimensions (cm) | Dimensions intérieures (cm) | Dimensioni int. (cm)

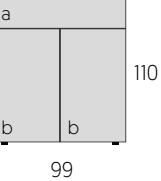
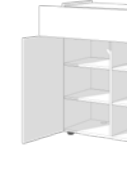
SL | KL | DT

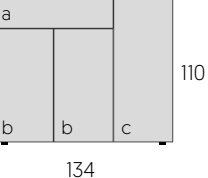

		JSC2085	a = DT b = SL c = DT	2x 48,1 94,0 2x 48,1	73,7 16,2 51,4	42,0 37,4 42,0
		JSC0412	a = DT	45,2	103,7	42,0
		JSC0413	a = SL b = DT	41,0 45,2	16,2 81,4	37,4 42,0
		JSC0912	a = DT	2x 46,6	103,7	42,0
		JSC0913	a = SL b = DT	91,0 2x 46,6	16,2 81,4	37,4 42,0
		JSC1312	a = DT	3x 42,1	103,7	42,0
		JSC1313	a = SL b = DT c = DT	81,9 2x 42,1 42,1	16,2 81,4 103,7	37,4 42,0 42,0

Just.Charlie – Sideboards

Bild | Image | Image | Immagine
Außenmaße (cm) ohne Füße bzw. Fußgleiter
 External dimensions (cm) without feet or foot glides
 Dimensions extérieures (cm) sans pieds ni patins
 Dimensioni esterne (cm) senza piedini o guide per i piedi

Artikel
 Article
 Article
 Articolo

Funktion
 Function
 Fonction
 Funzione

Innenmaße (cm)
 Internal dimensions (cm) | Dimensions intérieures (cm) | Dimensioni int. (cm)

SL | KL | DT

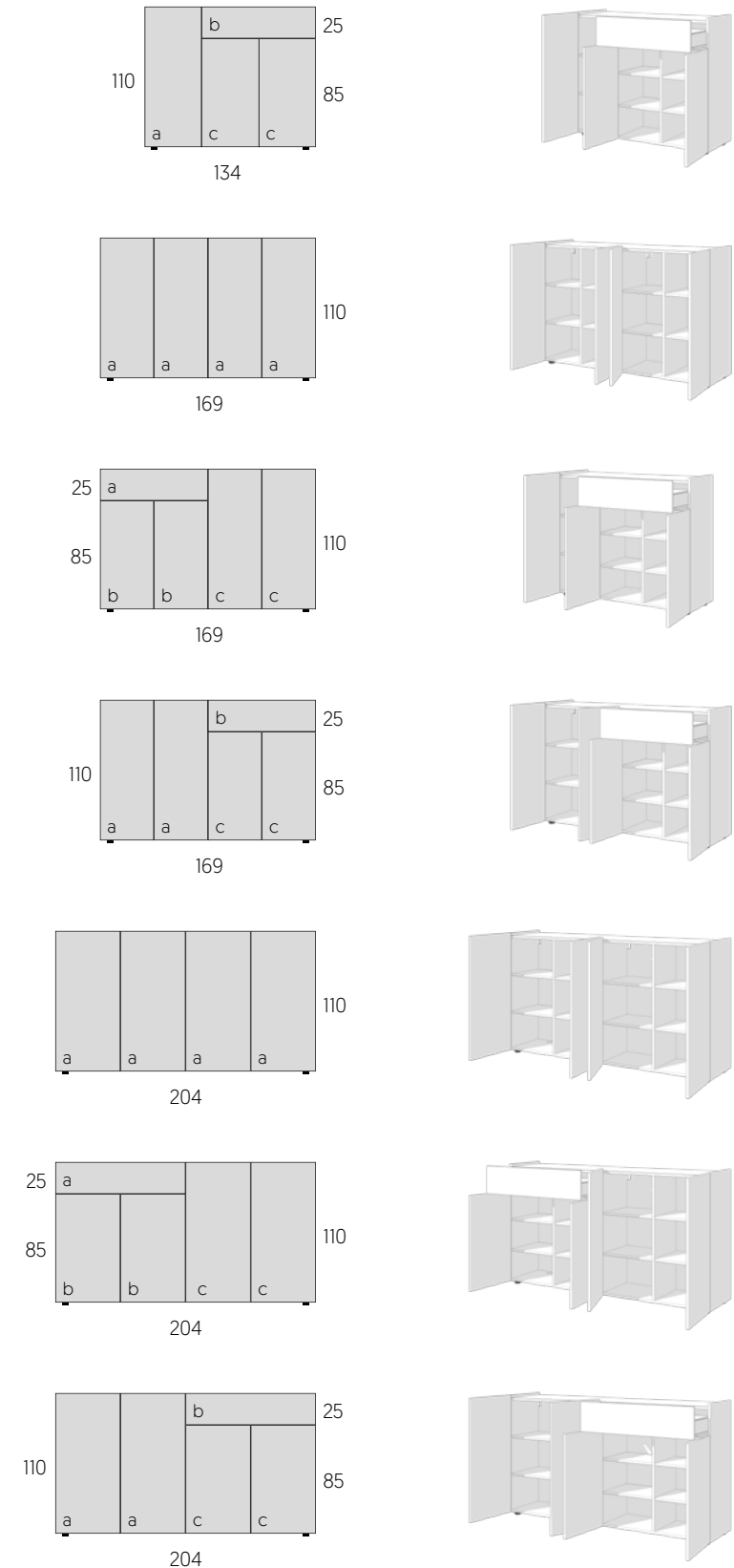
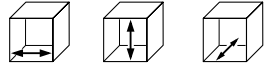

JSC1315

a = DT	42,1	103,7	42,0
b = SL	81,9	16,2	37,4
c = DT	2x 42,1	81,4	42,0

JSC1612

a = DT	4x 39,4	103,7	42,0
---------------	---------	-------	------

1 2

JSC1613

a = SL	76,5	16,2	37,4
b = DT	2x 39,4	81,4	42,0
c = DT	2x 39,4	103,7	42,0

1 2

JSC1615

a = DT	2x 39,4	103,7	42,0
b = SL	76,5	16,2	37,4
c = DT	2x 39,4	81,4	42,0

1 2

JSC2012

a = DT	4x 48,1	103,7	42,0
---------------	---------	-------	------

1 2

JSC2013

a = SL	94,0	16,2	37,4
b = DT	2x 48,1	81,4	42,0
c = DT	2x 48,1	103,7	42,0

1 2

JSC2015

a = DT	2x 48,1	103,7	42,0
b = SL	94,0	16,2	37,4
c = DT	2x 48,1	81,4	42,0

1 2

Just.Charlie – Optionen und Zubehör

Options and accessories | Options et accessoires | Opzioni e accessori

Bild
 Image
 Image
 Immagine

Artikel
 Article
 Article
 Articolo

Beschreibung
 Description
 Description
 Descrizione

€ | ⬆️

Aufstellarten | Installation types | Types d'installation | Sistema di montaggio

	Standard	Fußgleiter , ohne Aufpreis Foot glides, without surcharge Patins, sans supplément de prix Sottopiedi, senza sovrapprezzo	2,5 +1,0
	JSZ01	Design foot One , Set mit 5 Stück für Möbelbreite 134 – 204 cm Set of 5 pieces for furniture width 134 – 204 cm Set de 5 pièces pour meubles largeur 134 – 204 cm Set di 5 pezzi per mobili con larghezza 134 – 204 cm	13,0 +0,5
	JSZ01-4	Design foot One , Set mit 4 Stück für Möbelbreite 49 – 99 cm Set of 4 pieces for furniture width 49 – 99 cm Set de 4 pièces pour meubles largeur 49 – 99 cm Set di 4 pezzi per mobili con larghezza 49 – 99 cm	13,0 +0,5
	JSZ02	Design foot Two , Set mit 5 Stück für Möbelbreite 134 – 204 cm Set of 5 pieces for furniture width 134 – 204 cm Set de 5 pièces pour meubles largeur 134 – 204 cm Set di 5 pezzi per mobili con larghezza 134 – 204 cm	13,0 +0,5
	JSZ02-4	Design foot Two , Set mit 4 Stück für Möbelbreite 49 – 99 cm Set of 4 pieces for furniture width 49 – 99 cm Set de 4 pièces pour meubles largeur 49 – 99 cm Set di 4 pezzi per mobili con larghezza 49 – 99 cm	13,0 +0,5
	JSZ03	Design foot Three , Set mit 5 Stück für Möbelbreite 134 – 204 cm Set of 5 pieces for furniture width 134 – 204 cm Set de 5 pièces pour meubles largeur 134 – 204 cm Set di 5 pezzi per mobili con larghezza 134 – 204 cm	23,0 +0,5
	JSZ03-4	Design foot Three , Set mit 4 Stück für Möbelbreite 49 – 99 cm Set of 4 pieces for furniture width 49 – 99 cm Set de 4 pièces pour meubles largeur 49 – 99 cm Set di 4 pezzi per mobili con larghezza 49 – 99 cm	23,0 +0,5
	JSZ08	Wandmontage Kit für Möbelbreite 134 – 204 cm Wall mounting kit for furniture width 134 – 204 cm Kit de montage mural pour meubles largeur 134 – 204 cm Kit per il montaggio a parete per mobili con larghezza 134 – 204 cm	
	JSZ08-2	Wandmontage Kit für Möbelbreite 49 – 99 cm Wall mounting kit for furniture width 49 – 99 cm Kit de montage mural pour meubles largeur 49 – 99 cm Kit per il montaggio a parete per mobili con larghezza 49 – 99 cm	

	Option	Deckplatte wahlweise Colour Glas glänzend/satiniert (4 mm), Design Glas glänzend (4 mm) oder Holzdekor (12 mm) Top plate in Colour glass glossy/satin (4 mm), Design glass glossy (4 mm) or wood decor (12 mm) available Plateau supérieur en verre coloré brillant/satiné (4 mm), verre design brillant (4 mm) ou décor en bois (12 mm) disponible Top in vetro colorato lucido/satinato (4 mm), vetro di design lucido (4 mm) o decoro legno (12 mm) disponibile	
--	---------------	--	--

	JSZ20	LED-Beleuchtung, warmweiß, dimmbar, inklusive Fernbedienung LED lighting, warm white, dimmable, remote control included Éclairage LED, blanc chaud, intensité lumineuse variable, télécommande incluse Illuminazione LED, colore bianco caldo, dimmerabile, incluso telecomando	
--	--------------	---	--

Just.Charlie – colours & surfaces

Colours & surfaces | Couleurs & surfaces | Colori & superfici

Möbelfarben für Sideboards

Furniture colours for sideboards | Couleurs de meubles pour sideboards | Colori dei mobili per credenze

Uni Farben – pflegeleichte, matte Oberfläche (19 mm)

Plain colours – easy-care, matt surface (19 mm) | Couleurs unies – surface finition mate facile à entretenir (19 mm) |

Colori tinta unita – superficie opaca di facile manutenzione (19 mm)

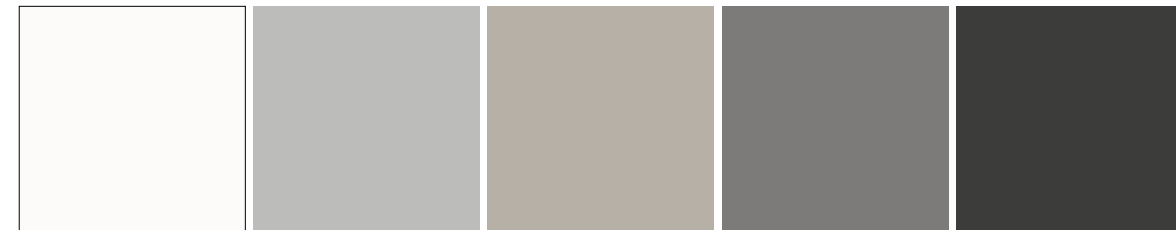

SNG Snow

GR Grey

PE Pebble

GN Granite

BG Black

Oberflächen für Deckplatten

Surfaces for top plates | Surfaces pour plateaux supérieures | Superfici per top

Colour Glas – glänzend oder satiniert (4 mm)

Colour glass – glossy or satin (4 mm) | Verre coloré – brillant ou satiné (4 mm) | Vetro colorato – lucido o satinato (4 mm)

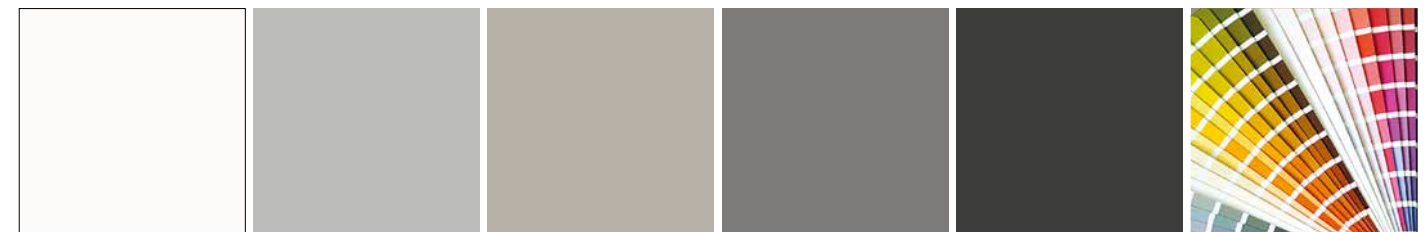

SNG Snow

GR Grey

PE Pebble

GN Granite

BG Black

NCS®/Sikkens 5051

Design Glas – glänzend (4 mm)

Design glass – glossy (4 mm)

Verre design – brillant (4 mm)

Vetro di design – lucido (4 mm)



DG100 Marmor Black

DG101 Marmor White

DG102 Marmor Grey

Holzdekor – strukturiert (12 mm)

Wood decor – textured (12 mm)

Décor en bois – structuré (12 mm)

Decoro in legno – strutturato (12 mm)



LO Light Oak

DP Deep Oak

Belastungsangaben & Technische Daten

Load & technical data | Charge et caractéristiques techniques | Indicazioni di carico & dati tecnici



92



Just.Lift JSL1524, Pebble / GRF

Jetzt einfach online konfigurieren
Simply configure online
www.justbyspectral.de





Motorische Liftfunktion mit Fernbedienung.
Zwei Modelle für TV-Geräte bis 55" und
TV-Geräte bis 65"

*Motorized lift function with remote control.
Two models for TVs up to 55" and TVs up to 65"*

*Fonction de soulèvement motorisé avec
télécommande. Deux modèles pour téléviseurs
jusqu'à 55" et téléviseurs jusqu'à 65"*

*Funzione TV lift motorizzato con telecomando.
Due modelli per TV fino a 55" e TV fino a 65"*

Eingefahren und aufgeräumt
Retracted and tidy
Rétracté et bien rangé
Ritirato e ordinato



Holzklappe in Korpusfarbe
oder Akustik Stoffklappe

*Wooden flap in cabinet colour or acoustic
fabric flap*

*Abattant en bois couleur meuble ou
abattant en tissu acoustique*

*Ribalta in legno in colore del mobile o
tessuto acustico*

Mittlere Rückwand von vorne abnehmbar
für einfachen Zugang zur TV-Lift-Einheit

*The centre rear panel can be removed from
the front for easy access to the TV lift unit*

*Le panneau arrière central peut être retiré
par l'avant pour un accès facile à l'élément
TV-Lift*

*Il pannello posteriore centrale può essere
rimosso dalla parte anteriore per facilitare
l'accesso del TV lift*



Soundbar Integration

Soundbar integration
Intégration d'une barre de son
Integrazione delle soundbar

Fußgleiter mit Höhenverstellung
Foot glides with height adjustment
Patins avec réglage en hauteur
Piedi con regolazione in altezza



**Durch zusätzliche Elemente zum Sideboard mit viel Stauraum erweiterbar.
Die Erweiterungselemente gibt es in zwei Breiten, diese können links und rechts vom TV-Lift-Element montiert werden.**

*Can be expanded into a sideboard with plenty of storage space using additional elements.
The extension elements are available in two widths and can be mounted to the left and right of the TV lift element.*

*Extensible par des éléments supplémentaires pour obtenir un sideboard avec de nombreux espaces de rangement.
Les éléments supplémentaires sont disponibles en deux largeurs et peuvent être montés à gauche ou à droite de
l'élément TV lift.*

*Può essere ampliato in una credenza con ampio spazio di contenimento utilizzando elementi aggiuntivi.
Le unità di estensione sono disponibili in due larghezze e possono essere montate a sinistra e a destra del TV lift.*

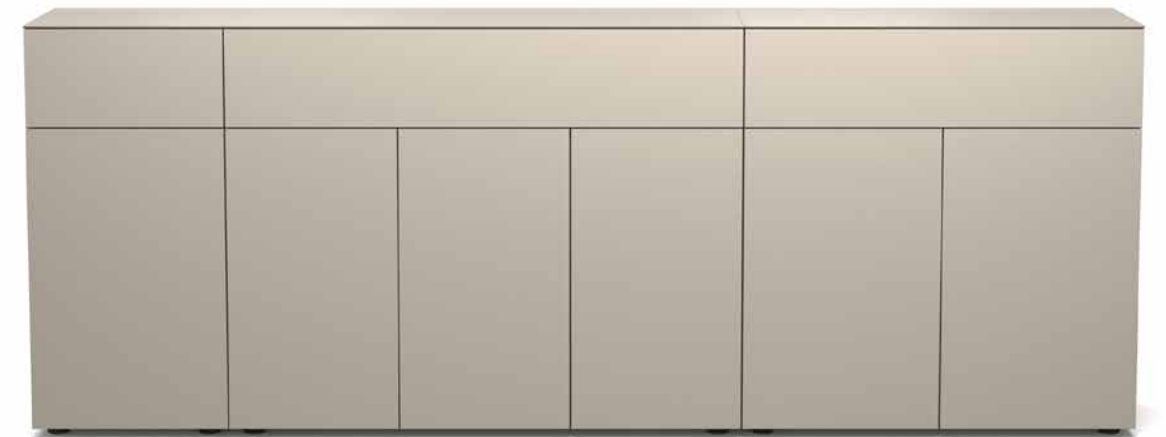

Just.Lift – TV Sideboards

Sideboards mit Schublade müssen an der Wand befestigt werden (Befestigungsmaterial wird mitgeliefert)
 Sideboards with drawer must be mounted to the wall (mounting kit is supplied)
 Les éléments avec tiroir doivent être fixés au mur (matériel de fixation fourni)
 I mobili con cassetto devono essere fissati alla parete (il materiale di fissaggio è in dotazione)



Tiefe gesamt außen 48,0 cm
 Total external depth
 Profondeur extérieure totale
 Profondità totale esterna

Bild | Image | Immagine
Außenmaße (cm) ohne Deckplatte, ohne Fußgleiter
 External dimensions (cm) without top plate, without feet
 Dimensions extérieures (cm) sans plateau supérieur, sans pieds
 Dimensioni esterne (cm) senza piastra di copertura, senza piedini

Artikel Article Articolo	Funktion Function Fonction Funzione	Innenmaße (cm) Internal dimensions (cm) Dimensions intérieures (cm) Dimensioni int. (cm)
	SL KL DT	

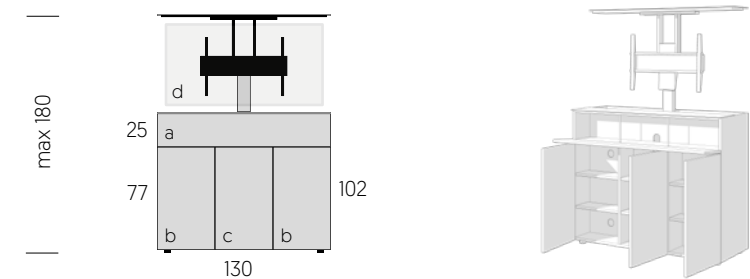

Artikel Article Articolo	Funktion Function Fonction Funzione	Innenmaße (cm) Internal dimensions (cm) Dimensions intérieures (cm) Dimensioni int. (cm)
JSL1300	a = KL b = DT c = DT	126,2 21,2 19,7 2x 40,8 75,1 19,7 40,8 75,1 18,9
	d = max. TV	124,0 85,0 6,5

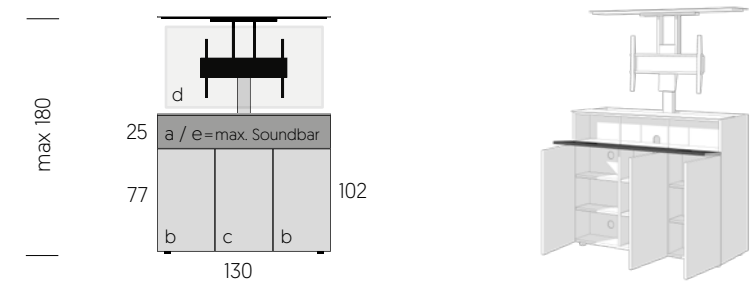

Artikel Article Articolo	Funktion Function Fonction Funzione	Innenmaße (cm) Internal dimensions (cm) Dimensions intérieures (cm) Dimensioni int. (cm)
JSL1304	a = KL b = DT c = DT	126,2 21,2 19,7 2x 40,8 75,1 19,7 40,8 75,1 18,9
	d = max. TV	124,0 85,0 6,5
	e e+ADX02	120,0 19,4 16,5 120,0 18,5 16,0

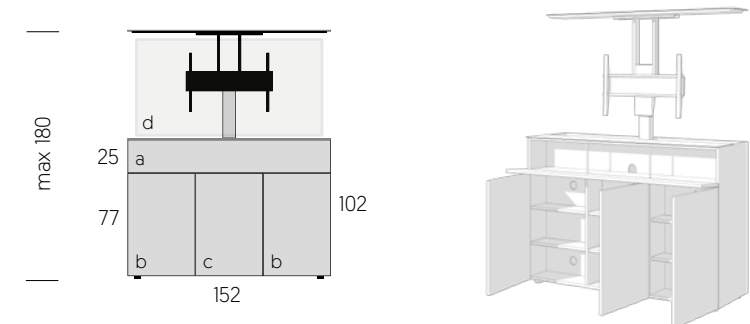

Artikel Article Articolo	Funktion Function Fonction Funzione	Innenmaße (cm) Internal dimensions (cm) Dimensions intérieures (cm) Dimensioni int. (cm)
JSL1520	a = KL b = DT c = DT	148,2 21,2 19,7 2x 48,1 75,1 19,7 48,1 75,1 18,9
	d = max. TV	146,0 85,0 6,5

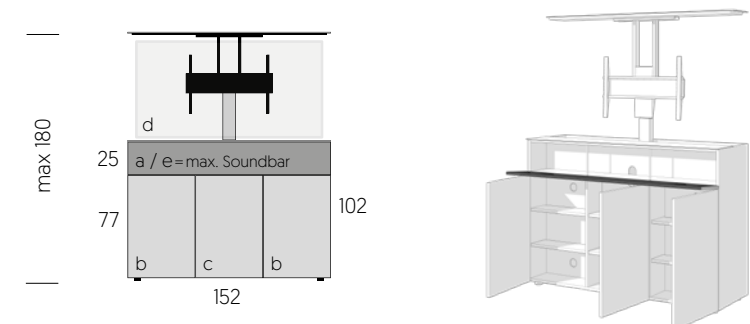

Artikel Article Articolo	Funktion Function Fonction Funzione	Innenmaße (cm) Internal dimensions (cm) Dimensions intérieures (cm) Dimensioni int. (cm)
JSL1524	a = KL b = DT c = DT	148,2 21,2 19,7 2x 48,1 75,1 19,7 48,1 75,1 18,9
	d = max. TV	146,0 85,0 6,5
	e e+ADX02	142,0 19,4 16,5 142,0 18,5 16,0

Just.Lift – Sideboards

Bild | Image | Immagine
Außenmaße (cm) ohne Deckplatte, ohne Fußgleiter
 External dimensions (cm) without top plate, without feet
 Dimensions extérieures (cm) sans plateau supérieur, sans pieds
 Dimensioni esterne (cm) senza piastra di copertura, senza piedini

Artikel Article Articolo	Funktion Function Fonction Funzione	Innenmaße (cm) Internal dimensions (cm) Dimensions intérieures (cm) Dimensioni int. (cm)
	SL KL DT	

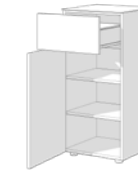
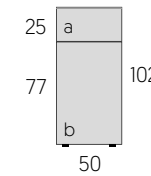

Artikel Article Articolo	Funktion Function Fonction Funzione	Innenmaße (cm) Internal dimensions (cm) Dimensions intérieures (cm) Dimensioni int. (cm)
JSL0503	a = SL b = DT	42,0 17,1 37,4 46,2 75,1 43,2

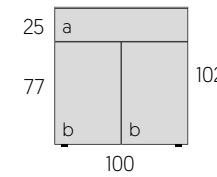

Artikel Article Articolo	Funktion Function Fonction Funzione	Innenmaße (cm) Internal dimensions (cm) Dimensions intérieures (cm) Dimensioni int. (cm)
JSL1003	a = SL b = DT	92,0 14,6 37,4 2x 47,1 75,1 43,2

Just.Lift – Optionen und Zubehör

Options and accessories | Options et accessoires | Opzioni e accessori

Bild Image Immagine	Artikel Article Articolo	Beschreibung Description Descrizione

Aufstellarten | Installation types | Types d'installation | Sistema di montaggio

Bild Image Immagine	Standard	Fußgleiter, ohne Aufpreis Foot glides, without surcharge Patins, sans supplément de prix Sottopiedi, senza sovrapprezzo	2,5 +1,0

Option	Deckplatte wahlweise Colour Glas glänzend/satiniert (4 mm), Design Glas glänzend (4 mm) oder Holzdekor (12 mm) Top plate in Colour glass glossy/satiné (4 mm), Design glass glossy (4 mm) or wood decor (12 mm) available Plateau supérieur en verre coloré brillant/satiné (4 mm), verre design brillant (4 mm) ou décor en bois (12 mm) disponible Top in vetro colorato lucido/satinato (4 mm), vetro di design lucido (4 mm) o decoro legno (12 mm) disponibile

ADX02	Universal Soundbar Ablage Höhenverstellbar, zur Unterbringung von Soundbar-Systemen verschiedener Hersteller in einem Element mit Stoffklappe. Height-adjustable universal soundbar tray to accommodate soundbar systems from different manufacturers in an element with fabric flap. Support universel pour barre de son réglable en hauteur pour accueillir des systèmes de barre de son de différents fabricants dans un élément avec un abattant en tissu. Adattatore universale per soundbar, regolabile in altezza, che consente di alloggiare sistemi soundbar di diversi produttori in un unico elemento, con anta in tessuto.

Just.Lift – colours & surfaces

Colours & surfaces | Couleurs & surfaces | Colori & superfici

Möbelfarben für Sideboards

Furniture colours for sideboards | Couleurs de meubles pour sideboards | Colori dei mobili per credenze

Uni Farben – pflegeleichte, matte Oberfläche (19 mm)

Plain colours – easy-care, matt surface (19 mm) | Couleurs unies – surface finition mate facile à entretenir (19 mm) |

Colori tinta unita – superficie opaca di facile manutenzione (19 mm)

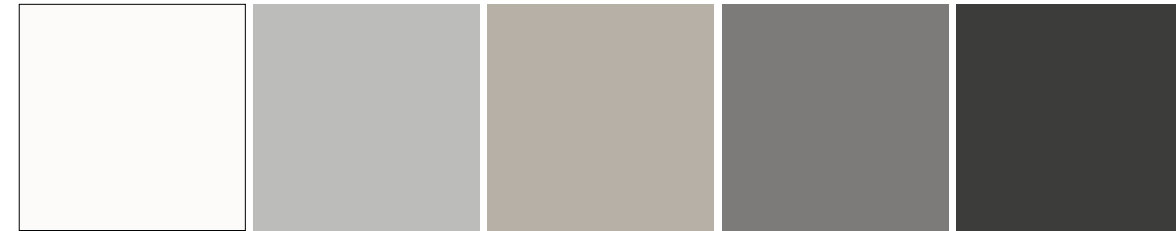

SNG Snow

GR Grey

PE Pebble

GN Granite

BG Black

Farben für Akustik Stoffklappen

Colours for acoustic fabric flaps | Couleurs pour les abatants acoustiques en tissu | Colori per ribalta in tessuto

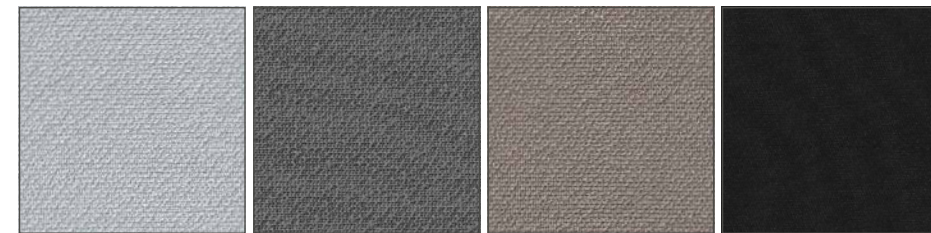

SF Silver

GRF Grey

PF Pebble

BF Black

Oberflächen für Deckplatten

Surfaces for top plates | Surfaces pour plateaux supérieures | Superfici per top

Colour Glas – glänzend oder satiniert (4 mm)

Colour glass – glossy or satin (4 mm) | Verre coloré – brillant ou satiné (4 mm) | Vetro colorato – lucido o satinato (4 mm)

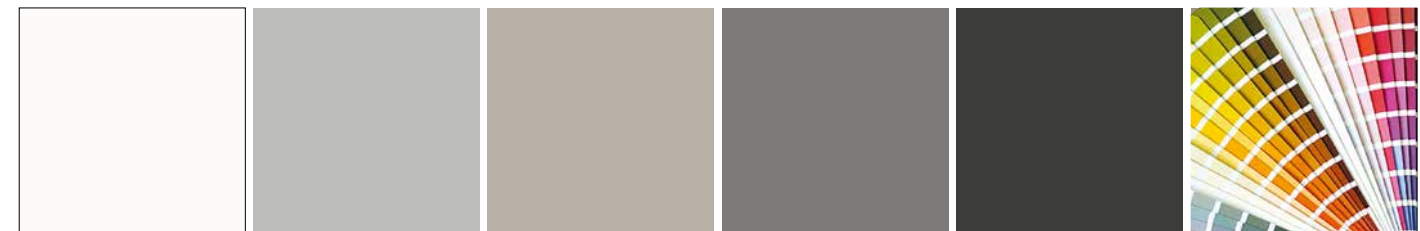

SNG Snow

GR Grey

PE Pebble

GN Granite

BG Black

NCS®/Sikkens 5051

Design Glas – glänzend (4 mm)

Design glass – glossy (4 mm)

Verre design – brillant (4 mm)

Vetro di design – lucido (4 mm)



DG100 Marmor Black

DG101 Marmor White

DG102 Marmor Grey

Holzdekor – strukturiert (12 mm)

Wood decor – textured (12 mm)

Décor en bois – structuré (12 mm)

Decoro in legno – strutturato (12 mm)



LO Light Oak

DP Deep Oak

Belastungsangaben & Technische Daten

Load & technical data | Charge et caractéristiques techniques | Indicazioni di carico & dati tecnici



92



▲ Just.Alpha JSA2044, Snow, Foot glides

◀ Just.Alpha JSA1640, Black, Design feet Two

Jetzt einfach online
konfigurieren
Simply configure online
www.justbyspectral.de





Universal TV-Halterung
 Universal TV mount
 Support TV universel
 Supporto TV universale



Qualität & Präzision
 Quality & precision
 Qualité & précision
 Qualità & precisione



TV-Cover aus Glas in Korpusfarbe
 TV cover made of glass in cabinet colour
 Cache TV en verre couleur meuble
 Copertura TV in vetro nel colore del mobile



Subwooferöffnung mit Abdeckung
 Subwoofer opening with cover
 Ouverture du caisson de basses avec
 couvercle associé
 Apertura del subwoofer con copertura



Bürsten zur Verkabelung
 Brushes for cable routing
 Brosses pour le passage des câbles
 Spazzole per il passaggio dei cavi



LED-Hintergrundbeleuchtung
 LED backlight
 Rétroéclairage par LED
 Retroilluminazione a LED



Praktische Innenraum-Gestaltung mit Stauraum für viele Geräte inkl. Soundbar. Robuste und pflegeleichte Oberflächen. In Verbindung mit einer Stofffront entsteht ein perfektes Sound Lowboard.

Practical interior design with storage space for many devices including a soundbar. Robust and easy-care surfaces. Combined with a fabric front, the result is a perfect sound lowboard.

Aménagement intérieur fonctionnel avec espace de rangement pour de nombreux appareils, y compris une barre de son. La surface mate intérieure est facile d'entretien et robuste. En combinaison avec une façade en tissu, c'est le meuble TV parfait.

Pratico design interno con spazio di contenimento per molti dispositivi, inclusa la soundbar. La superficie opaca dell'interno è facile da pulire e resistente. In combinazione con un frontale in tessuto, questo è il perfetto mobile TV.



Elegante Griffuge

*Elegant handle joint
 Éléphant joint de poignée
 Elegante maniglia nascosta*

Kratzfeste Glasoberfläche

*Scratch-resistant glass surface
 Surface en verre résistant aux rayures
 Superficie in vetro antigraffio*

Just.Alpha – Lowboards

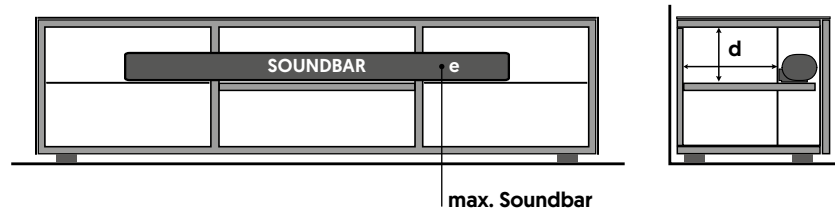

max. Soundbar

Bild | Image | Image | Immagine

Artikel
Article
Article
Articolo

Außenmaße (cm) ohne Füße bzw. Fußgleiter
External dimensions (cm) without feet or foot glides | Dimensions extérieures (cm) sans pieds ni patins | Dimensioni esterne (cm) senza piedini o guide per i piedi

Innenmaße (cm)
Internal dimensions (cm)
Dimensions intérieures (cm)
Dimensioni int. (cm)

➔ **Ab Lager lieferbar**
Available from stock
Disponibles depuis le stock
Disponibile in stock

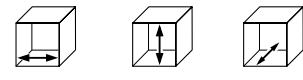
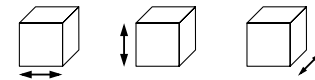

Lowboards mit Glasklappe

Lowboards with glass covered flap | Lowboards avec abattant en verre | Mobili TV con ribalta in vetro

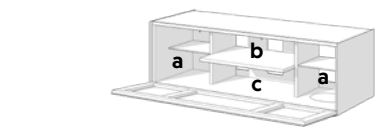

JSA1340

131,0 40,0 49,5

a 2x 32,0 35,8 41,5

b 58,4 16,9 41,0

c 58,4 16,9 41,5

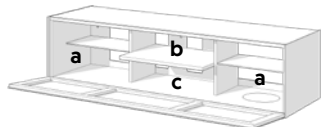

JSA1640

166,0 40,0 49,5

a 2x 49,5 35,8 41,5

b 58,4 16,9 41,0

c 58,4 16,9 41,5

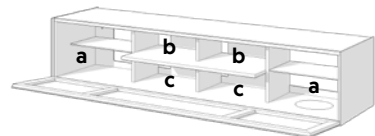

JSA2040

201,0 40,0 49,5

a 2x 49,5 35,8 41,5

b 2x 45,7 16,9 41,0

c 2x 45,7 16,9 41,5

Sound Lowboards mit Stoffklappe

Sound lowboards with fabric flap | Sound Lowboards avec abattant en tissu | Mobili TV audio con ribalta in tessuto

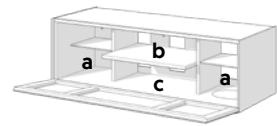

JSA1344

131,0 40,0 49,5

a 2x 32,0 35,8 41,5

b 58,4 16,9 41,0

c 58,4 16,9 41,5

d 58,4 16,9 27,4

e 120,0 14,3 14,0

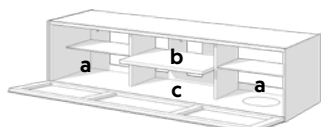

JSA1644

166,0 40,0 49,5



JSA1644-SNG-SAT

a 2x 49,5 35,8 41,5

b 58,4 16,9 41,0

c 58,4 16,9 41,5

d 58,4 16,9 27,4

e 155,0 14,3 14,0

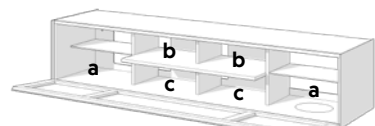

JSA2044

201,0 40,0 49,5



JSA2044-SNG-SAT

a 2x 49,5 35,8 41,5

b 2x 45,7 16,9 41,0

c 2x 45,7 16,9 41,5

d 2x 45,7 16,9 27,4

e 190,0 14,3 14,0

Just.Alpha – Optionen und Zubehör

Options and accessories | Options et accessoires | Opzioni e accessori

Bild	Artikel	Beschreibung
Image	Article	Description
Image	Article	Description
Immagine	Articolo	Descrizione

Aufstellarten | Installation types | Types d'installation | Sistema di montaggio



Standard

Fußgleiter, ohne Aufpreis

Foot glides, without surcharge | Patins, sans supplément de prix | Sottopiedi, senza sovrapprezzo

2,5 +1,0



JSZ05

Rollensockel

Castor base | Base à roulettes | Base a rotelle

4,5



JSZ01

Design foot One, Set mit 5 Stück

Set of 5 pieces | Set de 5 pièces | Set di 5 pezzi

13,0 +0,5



JSZ02

Design foot Two, Set mit 5 Stück

Set of 5 pieces | Set de 5 pièces | Set di 5 pezzi

13,0 +0,5



JSZ03

Design foot Three, Set mit 5 Stück

Set of 5 pieces | Set de 5 pièces | Set di 5 pezzi

23,0 +0,5

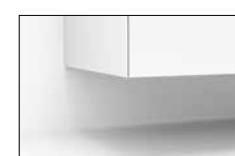

JSZ07

Wandmontage Kit

Wall mounting kit | Kit de montage mural | Kit per il montaggio a parete



Option

Deckplatte wahlweise Colour Glas glänzend/satiniert (4 mm) oder Design Glas glänzend (4 mm)

Top plate in Colour glass glossy/satin (4 mm) or Design glass glossy (4 mm) available

Plateau supérieur en verre coloré brillant/satiné (4 mm) ou verre design brillant (4 mm)





Top in vetro colorato lucido/satinato (4 mm) o vetro di design lucido (4 mm)

disponibile

Just.Alpha – Optionen und Zubehör

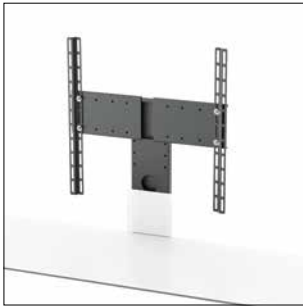
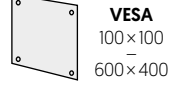
Options and accessories | Options et accessoires | Opzioni e accessori

➔ **Ab Lager lieferbar** | Available from stock | Disponibles depuis le stock | Disponibile in stock

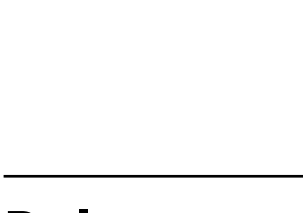
Bild Image Image Immagine	Artikel Article Article Articolo	Beschreibung Description Description Descrizione
	JSZ10	TV-Halterung TV mount Support TV Supporto TV + / - 15cm 27,8 / 31,8 / 35,8 / 39,8 cm  VESA 100×100 600×400 Inkl. Glas Cover, Kabelkanal und Universal Adapter für VESA Incl. glass cover, cable duct and universal adapter for VESA Incl. cache en verre, passage de câbles et adaptateur universel pour VESA Con top in vetro, canalina per cavi e adattatore universale per VESA
	JSZ10	TV-Halterung inkl. Glas Cover JSZ11-SNG-SAT TV mount incl. glass cover JSZ11-SNG-SAT Support TV avec cache en verre JSZ11-SNG-SAT Supporto TV con top in vetro JSZ11-SNG-SAT
	JSZ20 	LED-Beleuchtung LED lighting Éclairage LED Illuminazione a LED An der Hinterkante des Lowboards, warmweiß, dimmbar, inklusive Fernbedienung On the rear edge of the lowboard, warm white, dimmable, remote control included Sur le bord arrière du lowboard, blanc chaud, intensité lumineuse variable, télécommande incluse Indiretta sul bordo posteriore del mobile, colore bianco caldo, dimmerabile, incluso telecomando
	ZU1864	IR Link-System IR Link-System Système de liaison IR Sistema di collegamento IR Zur Steuerung von Audio- und Videogeräten bei geschlossener Möbelklappe For control of audio and video equipment when furniture flap is closed Pour la commande d'appareils audio et vidéo dans le cas de meubles fermés Per controllare le apparecchiature audio e video quando lo sportello del mobile è chiuso
	ZU2093	Universal Mediamount Universal media mount Support média universel Adattatore media Universale Geeignet für verschiedene Medienkomponenten, wird an der Rückseite der TV-Halterung befestigt For any media components, mounting on the rear of the TV mount Convient à de nombreux composants média, peut être fixé à l'arrière du support TV Adatto a molti componenti multimediali, può essere fissato sul retro del supporto TV

Belastungsangaben & Technische Daten

Load & technical data | Charge et caractéristiques techniques | Indicazioni di carico & dati tecnici

➔  92

Just.Alpha – colours & surfaces

Colours & surfaces | Couleurs & surfaces | Colori & superfici

Möbelfarben für Lowboards (Korpusfarbe innen)

Furniture colours for lowboards [Cabinet colour inside] | Couleurs de meubles pour lowboards [Couleur intérieure du meuble] | Colori dei mobili per credenze basse [Colore dei mobili all'interno]

Uni Farben – pflegeleichte, matte Oberfläche (19 mm)

Plain colours – easy-care, matt surface (19mm) | Couleurs unies – surface finition mate facile à entretenir (19mm) | Colori tinta unita – superficie opaca di facile manutenzione (19mm)

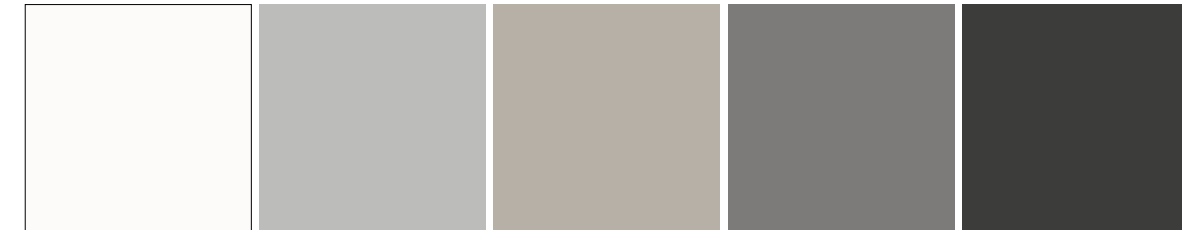

SNG Snow GR Grey PE Pebble GN Granite BG Black

Farben für Akustik Stoffklappen

Colours for acoustic fabric flaps | Couleurs pour les abattants acoustiques en tissu | Colori per ribalta in tessuto

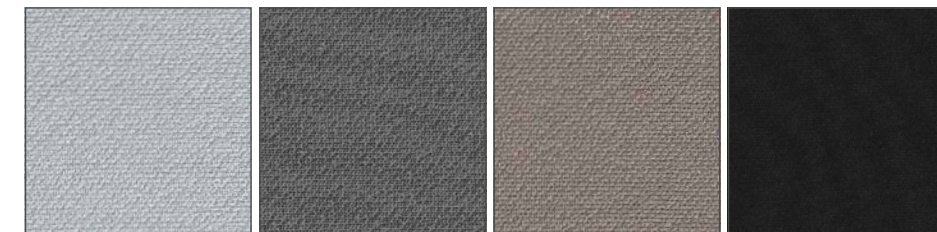

SF Silver GRF Grey PF Pebble BF Black

Glas Oberflächen

Glass surfaces | Surfaces en verre | Superfici in vetro

Colour Glas – glänzend oder satiniert (4 mm)

Colour glass – glossy or satin (4mm) | Verre coloré – brillant ou satiné (4mm) | Vetro colorato – lucido o satinato (4mm)

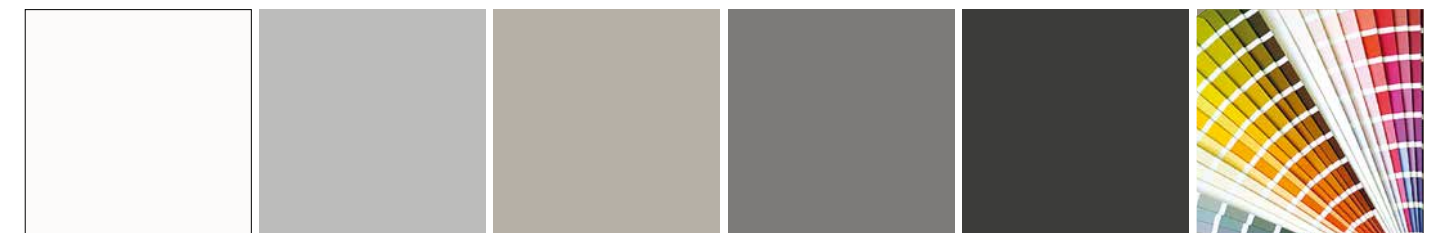

SNG Snow GR Grey PE Pebble GN Granite BG Black NCS®/Sikkens 5051

Design Glas – glänzend (4 mm, ausschließlich für Deckplatten erhältlich)

Design glass – glossy (4mm, exclusively available for top plates) | Verre design – brillant (4mm, disponible uniquement pour plateaux supérieurs) | Vetro di design – lucido (4mm, disponibile esclusivamente per il top di copertura)



DG100 Marmor Black DG101 Marmor White DG102 Marmor Grey



▲ Just.Bravo JSB2020, Pebble, TV-Mount, Design feet Three

◀ Just.Bravo JSB1620, Black, TV-Mount, Design feet One

Jetzt einfach online konfigurieren
Simply configure online
www.justbyspectral.de





Universal TV-Halterung
 Universal TV mount
 Support TV universel
 Supporto TV universale

Qualität & Präzision
 Quality & precision
 Qualité & précision
 Qualità & precisione



TV-Cover aus Glas in Korpusfarbe
 TV cover made of glass in cabinet colour
 Cache TV en verre couleur meuble
 Copertura TV in vetro nel colore del mobile

Subwooferöffnung mit Abdeckung
 Subwoofer opening with cover
 Ouverture du caisson de basses avec
 couvercle associé
 Apertura del subwoofer con copertura



Bürsten zur Verkabelung
 Brushes for cable routing
 Brosses pour le passage des câbles
 Spazzole per il passaggio dei cavi

LED-Hintergrundbeleuchtung
 LED backlight
 Rétroéclairage par LED
 Retroilluminazione a LED



Praktische Innenraum-Gestaltung mit Stauraum für viele Geräte inkl. Soundbar. Robuste und pflegeleichte Oberflächen. In Verbindung mit einer Stofffront entsteht ein perfektes Sound Lowboard.

Practical interior design with storage space for many devices including a soundbar. Robust and easy-care surfaces. Combined with a fabric front, the result is a perfect sound lowboard.

Aménagement intérieur fonctionnel avec espace de rangement pour de nombreux appareils, y compris une barre de son. La surface mate intérieure est facile d'entretien et robuste. En combinaison avec une façade en tissu, c'est le meuble TV parfait.

Pratico design interno con spazio di contenimento per molti dispositivi, inclusa la soundbar. La superficie opaca dell'interno è facile da pulire e resistente. In combinazione con un frontale in tessuto, questo è il perfetto mobile TV.



Elegante Griffleiste

*Elegant handle strip
 Poignée élégante
 Elegante maniglia di impugnatura*

Kratzfeste Glasoberfläche

*Scratch-resistant glass surface
 Surface en verre résistant aux rayures
 Superficie in vetro antigraffio*

Just.Bravo – Lowboards 25 cm



Bild | Image | Image | Immagine

Artikel
Article
Article
Articolo

Außenmaße (cm) ohne Füße bzw. Fußgleiter
External dimensions (cm) without feet or foot glides | Dimensions extérieures (cm) sans pieds ni patins | Dimensioni esterne (cm) senza piedini o guide per i piedi

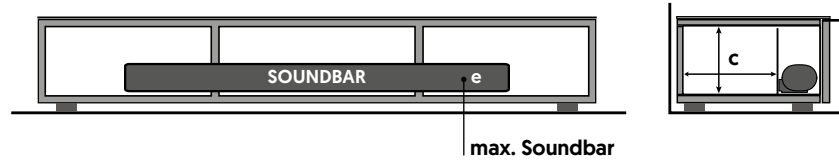
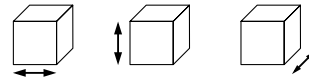

Innenmaße (cm)
Internal dimensions (cm)
Dimensions intérieures (cm)
Dimensioni int. (cm)

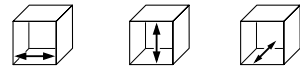

Lowboards mit Holzklappe

Lowboards with wooden flap | Lowboards avec abattant en bois | Mobili TV con ribalta in legno

	JSB1320	130,0	25,0	47,7	a	2x 32,0	20,8	39,8
					b	58,4	20,8	39,8
	JSB1620	165,0	25,0	47,7	a	2x 49,5	20,8	39,8
					b	58,4	20,8	39,8
	JSB2020	200,0	25,0	47,7	a	2x 49,5	20,8	39,8
					b	2x 45,7	20,8	39,8

Sound Lowboards mit Stoffklappe

Sound lowboards with fabric flap | Sound Lowboards avec abattant en tissu | Mobili TV audio con ribalta in tessuto

	JSB1324	130,0	25,0	47,7	a	2x 32,0	20,8	39,8
					b	58,4	20,8	39,8
					c	32,0 / 58,4	20,8	25,7
					e	120,0	18,2	14,0
	JSB1624	165,0	25,0	47,7	a	2x 49,5	20,8	39,8
					b	58,4	20,8	39,8
					c	49,5 / 58,4	20,8	25,7
					e	155,0	18,2	14,0
	JSB2024	200,0	25,0	47,7	a	2x 49,5	20,8	39,8
					b	2x 45,7	20,8	39,3
					c	49,5 / 45,7	20,8	25,7
					e	190,0	18,2	14,0

Just.Bravo – Lowboards 40 cm



Bild | Image | Image | Immagine

Artikel
Article
Article
Articolo

Außenmaße (cm) ohne Füße bzw. Fußgleiter
External dimensions (cm) without feet or foot glides | Dimensions extérieures (cm) sans pieds ni patins | Dimensioni esterne (cm) senza piedini o guide per i piedi

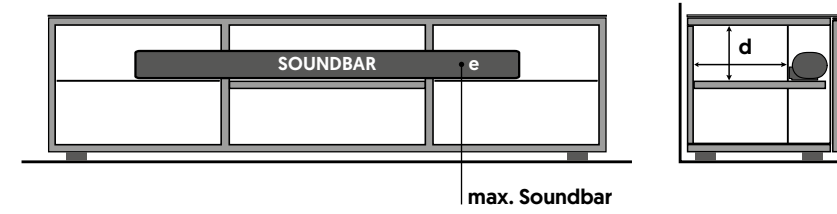
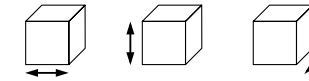

Innenmaße (cm)
Internal dimensions (cm)
Dimensions intérieures (cm)
Dimensioni int. (cm)

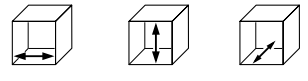

Lowboards mit Holzklappe

Lowboards with wooden flap | Lowboards avec abattant en bois | Mobili TV con ribalta in legno

	JSB1340	130,0	40,0	47,7	a	2x 32,0	35,8	39,8
					b	58,4	16,9	39,3
					c	58,4	16,9	39,8
	JSB1640	165,0	40,0	47,7	a	2x 49,5	35,8	39,8
					b	58,4	16,9	39,3
					c	58,4	16,9	39,8
	JSB2040	200,0	40,0	47,7	a	2x 49,5	35,8	39,8
					b	2x 45,7	16,9	39,3
					c	2x 45,7	16,9	39,8

Sound Lowboards mit Stoffklappe

Sound lowboards with fabric flap | Sound Lowboards avec abattant en tissu | Mobili TV audio con ribalta in tessuto







	JSB1344	130,0	40,0	47,7	a	2x 32,0	35,8	39,8
					b	58,4	16,9	39,3
					c	58,4	16,9	39,8
					d	58,4	16,9	25,7
					e	120,0	14,3	14,0
	JSB1644	165,0	40,0	47,7	a	2x 49,5	35,8	39,8
					b	58,4	16,9	39,3
					c	58,4	16,9	39,8
					d	58,4	16,9	25,7
					e	155,0	14,3	14,0
	JSB2044	200,0	40,0	47,7	a	2x 49,5	35,8	39,8
					b	2x 45,7	16,9	39,3
					c	2x 45,7	16,9	39,8
					d	2x 45,7	16,9	25,7
					e	190,0	14,3	14,0

Just.Bravo – Optionen und Zubehör

Options and accessories | Options et accessoires | Opzioni e accessori

Bild Image Image Immagine	Artikel Article Article Articolo	Beschreibung Description Description Descrizione	CE	↓↑
------------------------------------	---	---	----	----

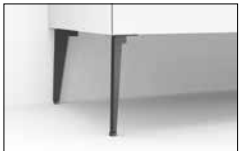
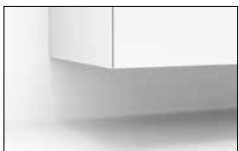
Aufstellarten | Installation types | Types d'installation | Sistema di montaggio

	Standard	Fußgleiter , ohne Aufpreis <i>Foot glides, without surcharge Patins, sans supplément de prix Sottopiedi, senza sovrapprezzo</i>	2,5	+1,0
	JSZ05	Rollensockel <i>Castor base Base à roulettes Base a rotelle</i>	4,5	
	JSZ01	Design foot One , Set mit 5 Stück <i>Set of 5 pieces Set de 5 pièces Set di 5 pezzi</i>	13,0	+0,5
	JSZ02	Design foot Two , Set mit 5 Stück <i>Set of 5 pieces Set de 5 pièces Set di 5 pezzi</i>	13,0	+0,5
	JSZ03	Design foot Three , Set mit 5 Stück <i>Set of 5 pieces Set de 5 pièces Set di 5 pezzi</i>	23,0	+0,5
	JSZ06	Wandmontage Kit für Höhe 25 cm <i>Wall mounting kit for height 25 cm Kit de montage mural pour hauteur 25 cm Kit per il montaggio a parete per altezza 25 cm</i>		
	JSZ07	Wandmontage Kit für Höhe 40 cm <i>Wall mounting kit for height 40 cm Kit de montage mural pour hauteur 40 cm Kit per il montaggio a parete per altezza 40 cm</i>		



	Option	Deckplatte wahlweise Colour Glas glänzend/satiniert (4 mm) oder Design Glas glänzend (4 mm) <i>Top plate in Colour glass glossy/satin (4 mm) or Design glass glossy (4 mm) available Plateau supérieur en verre coloré brillant/satiné (4 mm) ou verre design brillant (4 mm) Top in vetro colorato lucido/satinato (4 mm) o vetro di design lucido (4 mm) disponibile</i>		
--	---------------	--	--	--

Just.Bravo – Optionen und Zubehör

Options and accessories | Options et accessoires | Opzioni e accessori

→ **Ab Lager lieferbar** | Available from stock | Disponibles depuis le stock | Disponibile in stock

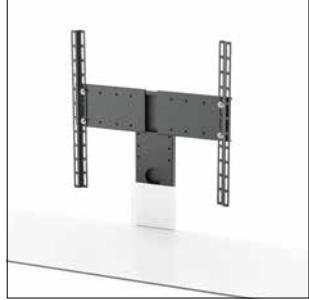
Bild Image Image Immagine	Artikel Article Article Articolo	Beschreibung Description Description Descrizione
------------------------------------	---	---

	JSZ10	TV-Halterung TV mount Support TV Supporto TV + / - 15 cm 27,8 / 31,8 / 35,8 / 39,8 cm VESA 100x100 - 600x400 Inkl. Glas Cover, Kabelkanal und Universal Adapter für VESA <i>Incl. glass cover, cable duct and universal adapter for VESA</i> <i>Incl. cache en verre, passage de câbles et adaptateur universel pour VESA</i> <i>Con top in vetro, canalina per cavi e adattatore universale per VESA</i>
	→ JSZ10	TV-Halterung inkl. Glas Cover JSZ11-SNG-SAT <i>TV mount incl. glass cover JSZ11-SNG-SAT</i> <i>Support TV avec cache en verre JSZ11-SNG-SAT</i> <i>Supporto TV con top in vetro JSZ11-SNG-SAT</i>
	→ JSZ20	LED-Beleuchtung LED lighting Éclairage LED Illuminazione a LED An der Hinterkante des Lowboards, warmweiß, dimmbar, inklusive Fernbedienung <i>On the rear edge of the lowboard, warm white, dimmable, remote control included</i> <i>Sur le bord arrière du lowboard, blanc chaud, intensité lumineuse variable, télécommande incluse</i> <i>Indiretta sul bordo posteriore del mobile, colore bianco caldo, dimmerabile, incluso telecomando</i>
	→ ZU1864	IR Link-System IR Link-System Système de liaison IR Sistema di collegamento IR Zur Steuerung von Audio- und Videogeräten bei geschlossener Möbelklappe <i>For control of audio and video equipment when furniture flap is closed</i> <i>Pour la commande d'appareils audio et vidéo dans le cas de meubles fermés</i> <i>Per controllare le apparecchiature audio e video quando lo sportello del mobile è chiuso</i>
	→ ZU2093	Universal Mediamount Universal media mount Support média universel Adattatore media Universale Geeignet für verschiedene Medienkomponenten, wird an der Rückseite der TV-Halterung befestigt <i>For any media components, mounting on the rear of the TV mount</i> <i>Convient à de nombreux composants média, peut être fixé à l'arrière du support TV</i> <i>Adatto a molti componenti multimediali, può essere fissato sul retro del supporto TV</i>

Belastungsangaben & Technische Daten

Load & technical data | Charge et caractéristiques techniques | Indicazioni di carico & dati tecnici

→  92

Just.Bravo – colours & surfaces

Colours & surfaces | Couleurs & surfaces | Colori & superfici

Möbelfarben für Lowboards

Furniture colours for lowboards | Couleurs de meubles pour lowboards | Colori dei mobili per credenze basse

Uni Farben – pflegeleichte, matte Oberfläche (19 mm)

Plain colours – easy-care, matt surface (19 mm) | Couleurs unies – surface finition mate facile à entretenir (19 mm) | Colori tinta unita – superficie opaca di facile manutenzione (19 mm)

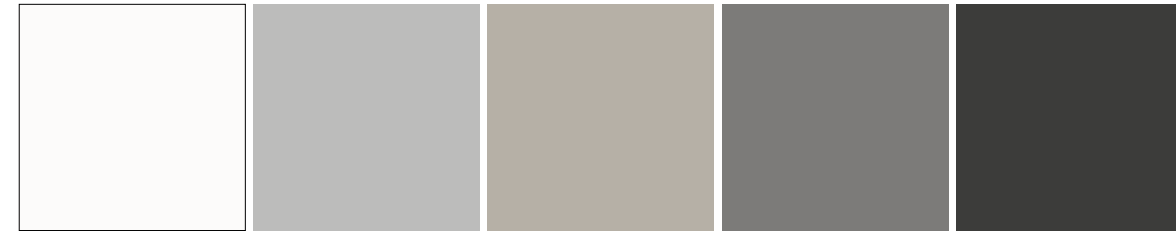

SNG Snow GR Grey PE Pebble GN Granite BG Black

Farben für Akustik Stoffklappen

Colours for acoustic fabric flaps | Couleurs pour les abatants acoustiques en tissu | Colori per ribalta in tessuto

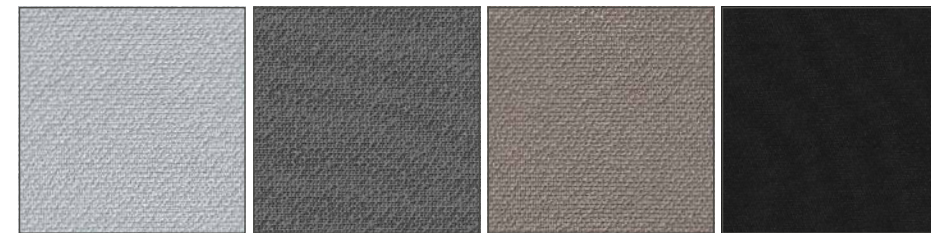

SF Silver GRF Grey PF Pebble BF Black

Oberflächen für Deckplatten

Surfaces for top plates | Surfaces pour plateaux supérieures | Superfici per top

Colour Glas – glänzend oder satiniert (4 mm)

Colour glass – glossy or satin (4 mm) | Verre coloré – brillant ou satiné (4 mm) | Vetro colorato – lucido o satinato (4 mm)

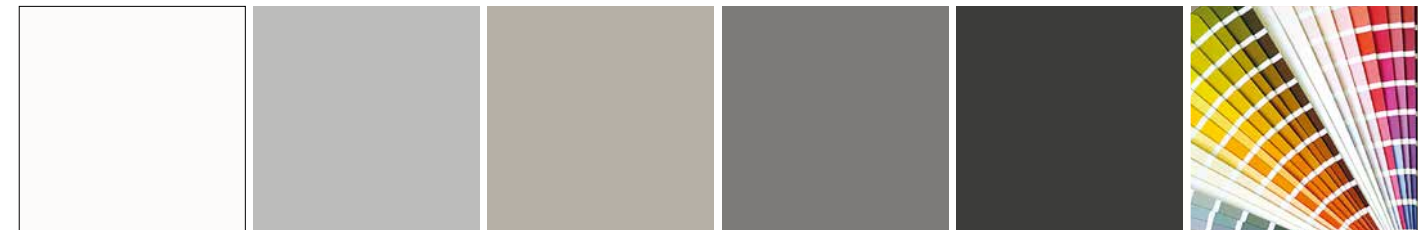

SNG Snow GR Grey PE Pebble GN Granite BG Black NCS®/Sikkens 5051

Design Glas – glänzend (4 mm)

Design glass – glossy (4 mm) | Verre design – brillant (4 mm) | Vetro di design – lucido (4 mm)



DG100 Marmor Black DG101 Marmor White DG102 Marmor Grey





Universal TV-Halterung
 Universal TV mount
 Support TV universel
 Supporto TV universale



Eingelassene Aluminium Griffkante
 Recessed aluminum handle edge
 Bord de la poignée en aluminium encastré
 Bordo maniglia incassato in alluminio



Gedämpfte Klappenmechanik
 Damped flap mechanism
 Mécanisme d'abattant amorti
 Meccanismo di sportello ammortizzato



▲ Just.Lima JRL2004, Snow, Universal soundbar tray

Praktische Innenraum-Gestaltung mit Stauraum für viele Geräte inkl. Soundbar. Robuste und pflegeleichte Oberflächen. In Verbindung mit einer Stofffront entsteht ein perfektes Sound Lowboard.

Practical interior design with storage space for many devices including a soundbar. Robust and easy-care surfaces. Combined with a fabric front, the result is a perfect sound lowboard.

Aménagement intérieur fonctionnel avec espace de rangement pour de nombreux appareils, y compris une barre de son. La surface mate intérieure est facile d'entretien et robuste. En combinaison avec une façade en tissu, c'est le meuble TV parfait.

Pratico design interno con spazio di contenimento per molti dispositivi, inclusa la soundbar. La superficie opaca dell'interno è facile da pulire e resistente. In combinazione con un frontale in tessuto, questo è il perfetto mobile TV.

Just.Lima – Lowboards



Bild Image Image Immagine	Artikel Article Article Articolo	Außenmaße (cm) ohne Füße External dimensions (cm) without feet Dimensions extérieures (cm) sans pieds Dimensioni est. (in cm), senza piedi	Innenmaße (cm) Internal dimensions (cm) Dimensions intérieures (cm) Dimensioni int. (cm)

Lowboards mit Holzklappe, glänzend
Lowboards with wooden flap, glossy | Lowboards avec abattant en bois, brillant | Mobili TV con ribalta in legno, lucido

	JRL1100T	111,0 30,4 48,0	a	2x 52,6 26,8 43,4
	JRL1650T	165,2 30,4 48,0	a	3x 52,6 26,8 43,4
	JRL1650T-SL	165,2 30,4 48,0	a b	2x 52,6 26,8 43,4 48,4 22,7 27,4
	JRL2000T	200,0 30,4 48,0	a	3x 64,2 26,8 43,4

Just.Lima – Sound Lowboards

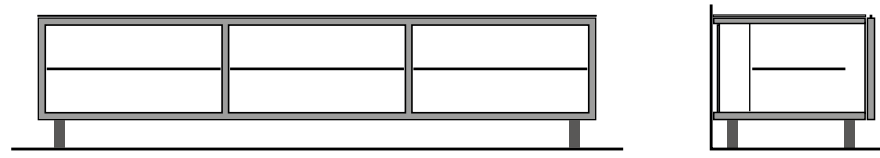
Sound lowboards | Sound Lowboards | Mobili TV audio con audio

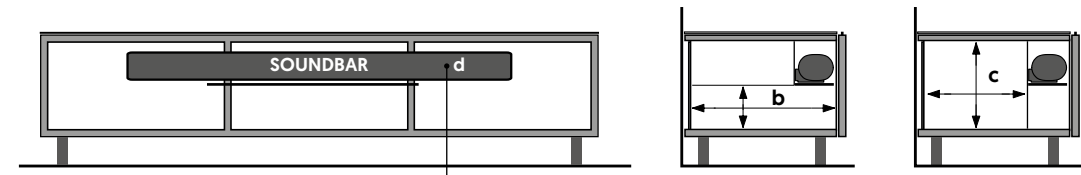

JRL + ADX02 (optional) max. Soundbar

Bild Image Image Immagine	Artikel Article Article Articolo	Außenmaße (cm) ohne Füße External dimensions (cm) without feet Dimensions extérieures (cm) sans pieds Dimensioni est. (in cm), senza piedi	Innenmaße (cm) Internal dimensions (cm) Dimensions intérieures (cm) Dimensioni int. (cm)

Ab Lager lieferbar
Available from stock
Disponibles depuis le stock
Disponibile in stock

Sound Lowboards mit Stoffklappe
Sound lowboards with fabric flap | Sound Lowboards avec abattant en tissu | Mobili TV audio con ribalta in tessuto

ADX02 ist nicht im Lieferumfang enthalten | ADX02 is not included in delivery | ADX02 n'est pas inclus | ADX02 non è incluso

	JRL1104T	111,0 30,4 48,0	a	2x 52,6 26,8 43,4
			b	2x 52,6 13,1 43,4
			c	2x 52,6 26,8 29,7
			d	100,3 24,0 12,4
			d + ADX02	100,3 20,5 11,6
	JRL1654T-BG JRL1654T-SNG	165,2 30,4 48,0	a	3x 52,6 26,8 43,4
			b	3x 52,6 13,1 43,4
			c	3x 52,6 26,8 29,7
			d	154,5 24,0 12,4
			d + ADX02	154,5 20,5 11,6
	JRL2004T-BG JRL2004T-SNG	200,0 30,4 48,0	a	3x 64,2 26,8 43,4
			b	3x 64,2 13,1 43,4
			c	3x 64,2 26,8 29,7
			d	189,3 24,0 12,4
			d + ADX02	189,3 20,5 11,6

Just.Lima – Aufstellarten





Installation types | Types d'installation | Sistema di montaggio

Bild Image Image Immagine	Artikel Article Article Articolo	Beschreibung Description Description Descrizione	€ ⬆️
	Standard	Stick	7,6 +1,0

Just.Lima – Optionen und Zubehör

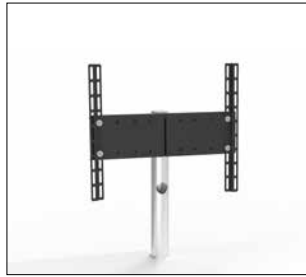
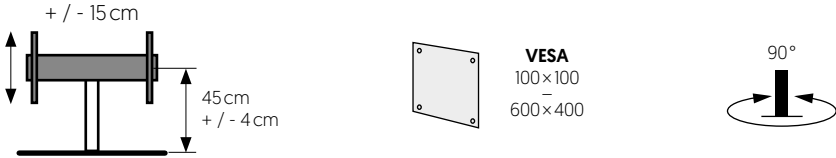
Options and accessories | Options et accessoires | Opzioni e accessori

➔ **Ab Lager lieferbar** | Available from stock | Disponibles depuis le stock | Disponibile in stock

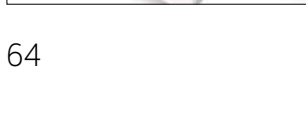
Bild Image Image Immagine	Artikel Article Article Articolo	Beschreibung Description Description Descrizione
	T60-600	TV-Halterung, Aluminium, inkl. Universal VESA Adapter TV mount, Aluminium, incl. universal VESA adapter Supporto TV, Aluminium, adattatore VESA universale inclus Supporto TV, alluminio, incl. adattatore VESA universale 
	SPMEX1	Extension Kit VESA 600x600 für Universal VESA Adapter For universal VESA adapter Pour adaptateur VESA universel Per adattatore VESA universale
	ADX02	Universal Soundbar Ablage Höhenverstellbar, zur Unterbringung von Soundbar-Systemen verschiedener Hersteller in einem Element mit Stoffklappe. Height-adjustable universal soundbar tray to accommodate soundbar systems from different manufacturers in an element with fabric flap. Support universel pour barre de son réglable en hauteur pour accueillir des systèmes de barre de son de différents fabricants dans un élément avec un abattant en tissu. Adattatore universale per soundbar, regolabile in altezza, che consente di alloggiare sistemi soundbar di diversi produttori in un unico elemento, con anta in tessuto.
	ZU1864	IR Link-System IR Link-System Système de liaison IR Sistema di collegamento IR Zur Steuerung von Audio- und Videogeräten bei geschlossener Möbelklappe For control of audio and video equipment when furniture flap is closed Pour la commande d'appareils audio et vidéo dans le cas de meubles fermés Per controllare le apparecchiature audio e video quando lo sportello del mobile è chiuso
	ZU2093	Universal Mediamount Universal media mount Support média universel Adattatore media Universale Geeignet für verschiedene Medienkomponenten, wird an der Rückseite der TV-Halterung befestigt For any media components, mounting on the rear of the TV mount Convient à de nombreux composants média, peut être fixé à l'arrière du support TV Adatto a molti componenti multimediali, può essere fissato sul retro del supporto TV
	ZU2139	Abdeckung für Kabelöffnung, Weiß Cover for cable opening, white Couvercle pour l'ouverture du câble de couleur blanche Coperchio per apertura cavi di colore bianco
	ZU2140	Abdeckung für Kabelöffnung, Schwarz Cover for cable opening, black Couvercle pour l'ouverture du câble de couleur noir Coperchio per apertura cavi di colore nero
	JRSLE01	Einsatz zur Innereinteilung für Schublade, für Lowboard JRL1650T-SL Insert for interior arrangement for drawer, for lowboard JRL1650T-SL Insert pour compartimenter l'intérieur du tiroir, pour lowboard JRL1650T-SL Inserto divisorio interno per cassetto, per modello JRL1650T-SL

Just.Lima – colours & surfaces

Colours & surfaces | Couleurs & surfaces | Colori & superfici

Kombinationen für Möbel-/ Frontfarben bei Lowboards

Combinations for furniture / front colours for lowboards | Combinaisons pour couleurs des meuble / de façades pour meuble | Combinazioni di colori per mobili / frontali per lavagne

Colour Glas – glänzend (4 mm)

Colour glass – glossy (4 mm) | Verre coloré – brillant (4 mm) | Vetro colorato – lucido (4 mm)

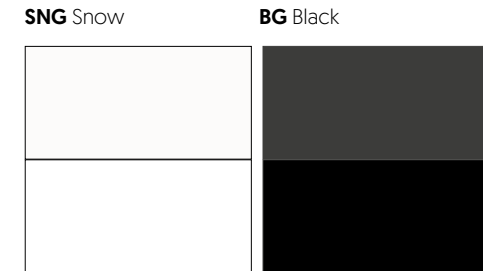

SNG Snow BG Black

Uni Farben – pflegeleichte, glänzende Oberfläche (19 mm)

Plain colours – easy-care, glossy surface (19 mm) | Couleurs unies – surface finition brillant facile à entretenir (19 mm) | Colori tinta unita – superficie lucido di facile manutenzione (19 mm)

Kombinationen für Möbel-/ Stofffarben bei Sound Lowboards

Combinations for furniture / fabric colours for sound lowboards | Combinaisons pour couleurs des meuble / tissu pour meuble avec son | Combinazioni di colori per mobili / tessuti per mobili TV audio

Colour Glas – glänzend (4 mm)

Colour glass – glossy (4 mm) | Verre coloré – brillant (4 mm) | Vetro colorato – lucido (4 mm)

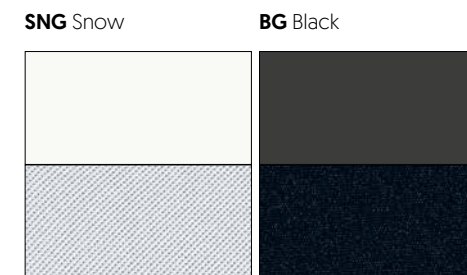

SF Silver BF Black

Akustik Stoffklappe | Acoustic fabric flap | Abattant accoustique en tissu | Anta a ribalta rivestita in tessuto

Belastungsangaben & Technische Daten

Load & technical data | Charge et caractéristiques techniques | Indicazioni di carico & dati tecnici





▲ Just.Basic JRB1304, Snow / Grey



▲ Just.Basic JRB1604, Grey / Grey, TV-Mount T60-600

Jetzt einfach online konfigurieren
Simply configure online
www.justbyspectral.de



Just.Basic – Sound Lowboards

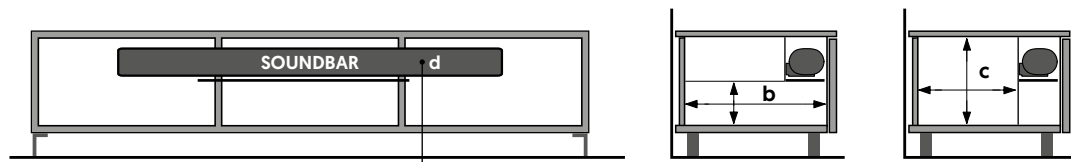

JRB + ADX02 (optional) max. Soundbar

Bild Image Image Immagine	Artikel Article Article Articolo	Außenmaße [cm] ohne Füße External dimensions [cm] without feet Dimensions extérieures [cm] sans pieds Dimensioni est. [in cm], senza piedi	Innenmaße [cm] Internal dimensions [cm] Dimensions intérieures [cm] Dimensioni int. [cm]
------------------------------------	---	---	---

➔ **Ab Lager lieferbar**
Available from stock
Disponibles depuis le stock
Disponibile in stock



Sound Lowboards mit Stoffklappe

Sound lowboards with fabric flap | Sound Lowboards avec abattant en tissu | Mobili TV audio con ribalta in tessuto

	➔ JRB1304-SNG	130,0	38,0	40,0	a	2x 62,1	26,2	33,9
	➔ JRB1304-GR				b	2x 62,1	12,5	33,9
					c	2x 62,1	26,2	20,5
					d	119,5	22,0	11,9
					d + ADX02	119,5	20,5	11,6
	➔ JRB1604-SNG	160,0	38,0	40,0	a	3x 50,8	26,2	33,9
	➔ JRB1604-GR				b	3x 50,8	12,5	33,9
					c	3x 50,8	26,2	20,5
					d	149,5	22,0	11,9
					d + ADX02	149,5	20,5	11,6

Just.Basic – Aufstellarten

Installation types | Types d'installation | Sistema di montaggio

Bild Image Image Immagine	Artikel Article Article Articolo	Beschreibung Description Description Descrizione	CEI	⚡
------------------------------------	---	---	-----	---

	Standard	Fuß Foot Pied Piedini	8,0	-
--	-----------------	------------------------------------	-----	---

Belastungsangaben & Technische Daten

Load & technical data | Charge et caractéristiques techniques | Indicazioni di carico & dati tecnici

➔ 92

Just.Basic – Optionen und Zubehör

Options and accessories | Options et accessoires | Opzioni e accessori

➔ **Ab Lager lieferbar** | Available from stock | Disponibles depuis le stock | Disponibile in stock

Bild Image Image Immagine	Artikel Article Article Articolo	Beschreibung Description Description Descrizione
------------------------------------	---	---

	➔ T60-600	TV-Halterung, Aluminium, inkl. Universal VESA Adapter TV mount, Aluminium, incl. universal VESA adapter Support TV, Aluminium, adaptateur VESA universel inclus Supporto TV, alluminio, incl. adattatore VESA universale
	➔ SPMEX1	Extension Kit VESA 600 x 600 für Universal VESA Adapter For universal VESA adapter Pour adaptateur VESA universel Per adattatore VESA universale

	➔ ADX02	Universal Soundbar Ablage Höhenverstellbar, zur Unterbringung von Soundbar-Systemen verschiedener Hersteller in einem Element mit Stoffklappe Height-adjustable universal soundbar tray to accommodate soundbar systems from different manufacturers in an element with fabric flap. Support universel pour barre de son réglable en hauteur pour accueillir des systèmes de barre de son de différents fabricants dans un élément avec un abattant en tissu. Adattatore universale per soundbar, regolabile in altezza, che consente di alloggiare sistemi soundbar di diversi produttori in unico elemento, con anta in tessuto.
--	----------------	--

	➔ ZU2093	Universal Mediamount Universal media mount Support média universel Adattatore media Universale Geeignet für verschiedene Medienkomponenten, wird an der Rückseite der TV-Halterung befestigt For any media components, mounting on the rear of the TV mount Convient à de nombreux composants média, peut être fixé à l'arrière du support TV Adatto a molti componenti multimediali, può essere fissato sul retro del supporto TV
--	-----------------	--

Just.Basic – colours & surfaces

Colours & surfaces | Couleurs & surfaces | Colori & superfici

Kombinationen für Möbel-/ Stofffarben bei Sound Lowboards

Combinations for furniture/fabric colours for sound lowboards | Combinaisons pour couleurs des meuble/tissu pour meuble avec son | Combinazioni di colori per mobili/tessuti per mobili TV audio

Uni Farben – pflegeleichte, matte Oberfläche (19 mm)

Plain colours – easy-care, matt surface [19mm] | Couleurs unies – surface finition mate facile à entretenir [19mm] | Colori tinta unita – superficie opaca di facile manutenzione [19mm]



GRF Grey GRF Grey

Akustik Stoffklappe | Acoustic fabric flap | Abattant acoustique en tissu | Anta a ribalta rivestita in tessuto



Just.Delta ist als offenes Regal, Glasvitrine oder geschlossener Hängeschrank erhältlich.

Just.Delta is available as an open wall cabinet, as a display cabinet or as a closed wall cabinet.

Just.Delta est disponible en version étagère ouverte vitrine en verre ou étagère fermée.

Just.Delta è disponibile come pensile a giorno, come vetrina oppure come pensile chiuso.

◀ Just.Delta JSD0216, Deep Oak
Just.Delta JSD0315, Pebble

Jetzt einfach online konfigurieren
Simply configure online
www.justbyspectral.de





Türen mit Push-to-Open Mechanik
Doors with push-to-open mechanism
Portes avec mécanisme push-to-open
Ante con meccanismo push-to-open



Höhenverstellbare Glaseinlegeböden
Height-adjustable glass shelves
Étagères en verre réglables en hauteur
Ripiani in vetro regolabili in altezza



Stabile, einstellbare Wandaufhängung
Sturdy, adjustable wall mounting
Suspension murale robuste et réglable
Supporto a parete robusta e regolabile

Bild Image Image Immagine	Tiefe gesamt außen 30,0 cm	Artikel	Funktion	Innenmaße (cm)
Außenmaße (cm) External dimensions (cm) Dimensions extérieures (cm) Dimensioni est. (in cm)	Total external depth Profondeur extérieure totale Profondità totale esterna	Article Article Articolo	Function Fonction Funzione	Internal dimensions (cm) Dimensions intérieures (cm) Dimensioni int. (cm)

Offenes Element	JSD0216	a	16,2	32,0	27,5
Open element Élément ouvert Elemento a giorno		b	16,2	21,5	27,5
		c	16,2	38,9	27,5

Element mit Tür	JSD0312	a = DT	26,2	96,2	25,2
Element with door Élément avec porte Elemento con anta					

Element mit Vitrintentür	JSD0315	a = DT	26,2	96,2	25,2
Element with display door Élément avec porte vitrée Elemento con porta vetrina					

Just.Delta – colours & surfaces

Colours & surfaces | Couleurs & surfaces | Colori & superfici

Uni Farben – pflegeleichte, matte Oberfläche (19 mm)

Plain colours – easy-care, matt surface (19 mm) | Couleurs unies – surface finition mate facile à entretenir (19 mm) | Colori tinta unita – superficie opaca di facile manutenzione (19 mm)

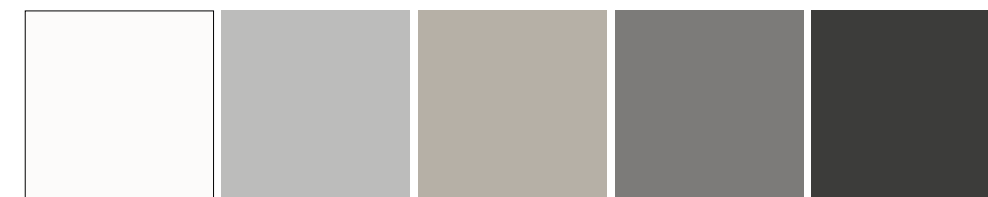

SNG Snow GR Grey PE Pebble GN Granite BG Black

Holzdekor – strukturiert (12 mm)

Wood decor – textured (12 mm) | Décor en bois – structuré (12 mm) | Decoro in legno – strutturato (12 mm)



LO Light Oak DP Deep Oak

Belastungsangaben & Technische Daten

Load & technical data | Charge et caractéristiques techniques | Indicazioni di carico & dati tecnici



Tables

MADE IN GERMANY



◀ Just.Tango JST9040, Granite / Marmor White

Jetzt einfach online konfigurieren
 Simply configure online
www.justbyspectral.de



Just.Tango – Details



Zwei Tischvarianten mit und ohne Ablagefach
 Two table variants with and without storage compartment
 Deux variantes de table avec et sans compartiment de rangement
 Due varianti di tavolo con e senza vano portaoggetti



Verschiedene Deckplatten zur Wahl
 Choice of various top plates
 Choix de différentes plateaux supérieures
 Scelta di varie versioni top



Höhenverstellbare Designfüße
 Height-adjustable Design feet
 Pieds design réglables en hauteur
 Piedi di design regolabili in altezza

Just.Tango – Tables

Bild | Image | Image | Immagine
Außenmaße (cm) inkl. Füße, ohne Deckplatte
 External dimensions (cm) with feet, without top plate
 Dimensions extérieures (cm) avec pieds, sans plateau supérieure
 Dimensioni est. (in cm) con piedi, senza top



Tiefe gesamt außen 56,0 cm
 Total external depth
 Profondeur extérieure totale
 Profondità totale esterna

Artikel
 Article
 Articolo

Innenmaße (cm)
 Internal dimensions (cm) | Dimensions intérieures (cm) | Dimensioni int. (cm)

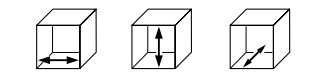

JST9025

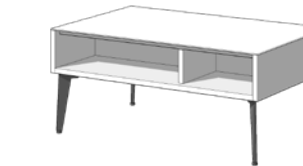
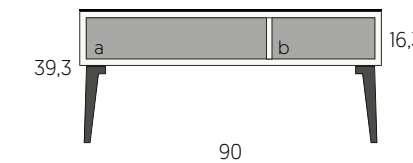

JST9040

a	2x 53,6	12,5	27,0
b	2x 30,7	12,5	27,0

Just.Tango – colours & surfaces

Colours & surfaces | Couleurs & surfaces | Colori & superfici

Oberflächen für Korpus JST9040

Surfaces for cabinet JST9040 | Surfaces pour élément JST9040 | Superfici per struttura JST9040

Uni Farben – pflegeleichte, matte Oberfläche (19 mm)

Plain colours – easy-care, matt surface (19mm) | Couleurs unies – surface finition mate facile à entretenir (19mm) | Colori tinta unita – superficie opaca di facile manutenzione (19mm)

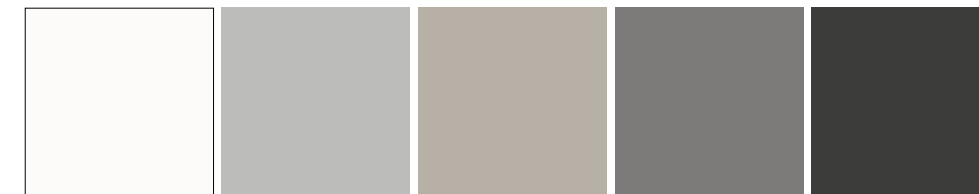

SNG Snow **GR** Grey **PE** Pebble **GN** Granite **BG** Black

Oberflächen für Deckplatten JST9025 / JST9040

Surfaces for top plates JST9025/JST9040 | Surfaces pour plateaux supérieures JST9025/JST9040 | Superficie per top JST9025/JST9040

Colour Glas – glänzend oder satiniert (4 mm)



SNG Snow **GR** Grey **PE** Pebble **GN** Granite **BG** Black



NCS®/Sikkens 5051

Design Glas – glänzend (4 mm)



DG100 Marmor Black **DG101** Marmor White **DG102** Marmor Grey

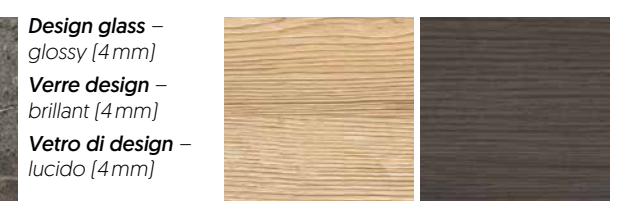

LO Light Oak **DP** Deep Oak

Colour glass – glossy or satin (4mm)
Verre coloré – brillant ou satiné (4mm)
Vetro colorato – lucido o satinato (4mm)

Wood decor – textured (12mm)
Décor en bois – structuré (12mm)
Decoro in legno – strutturato (12mm)



Jetzt einfach online konfigurieren
Simply configure online
www.justbyspectral.de





Monitorhalterung
 Monitor mount
 Support du moniteur
 Staffa per monitor



Smart Charge
 Smart Charge
 Smart Charge
 Smart Charge



Tischplatte
 Tabletop
 Plateau de table
 Piano scrivania



Bedienelement
 Control element
 Élément d'utilisation
 Pannello di controllo



Tischgestell
 Desk frame
 Cadre de table
 Telaio della scrivania



Kabelmanagement
 Cable management
 Gestion des câbles
 Gestione dei cavi



Bild Image Image Immagine	Artikel Article Article Articolo	Farbe Colour Couleur Colore	Außenmaße [cm] External dimensions [cm] Dimensions extérieures [cm] Dimensioni est. [in cm]		

Tischgestelle | Desk frames | Cadres de table | Cornici dei tavoli



JO-EDFI-BG	Black	100,0–170,0	62,0–128,0	65,0
JO-EDFI-GR	Grey	100,0–170,0	62,0–128,0	65,0
JO-EDFI-SNG	Snow	100,0–170,0	62,0–128,0	65,0

Tischplatten | Tabletops | Plateaux de table | Tavoli

Bei Tischplatten-Breite bis 160 cm sind zwei Kabeldurchlässe (links/rechts) verbaut.

For tabletops with a width of up to 160 cm, two cable ducts (left/right) are installed.
Les largeurs de plateau jusqu'à 160 cm disposent de deux sorties de câble (gauche/droite).
Le larghezze del piano del tavolo fino a 160cm hanno due uscite cavi (sinistra/destra).

Bei Tischplatten-Breite ab 160,1cm sind drei Kabeldurchlässe (links/mittig/rechts) verbaut.

For tabletops from 160,1cm width, three cable ducts (left/center/right) are installed.
Trois sorties de câbles (gauche/milieu/droite) sont installées pour des largeurs de table à partir de 160,1cm.
Tre uscite cavi (sinistra/metà/destra) sono installate per piani da lavoro a partire da 160,1cm di larghezza.

Standard

	JO-DT1608	160,0	1,9	80,0
	JO-DT1808	180,0	1,9	80,0

Flexibel | Flexible | Flexible | Flessibile

	JO-DT-FLEX	120,0 – 200,0	1,9	70,0 – 100,0
--	-------------------	---------------	-----	--------------

Zubehör ist ab Lager lieferbar

Accessories are available from stock | Les accessoires sont disponibles depuis le stock | Gli accessori sono disponibili in stock

Bild Image Image Immagine	Artikel Article Article Articolo	Beschreibung Description Description Descrizione
------------------------------------	---	---



JO-MM1-SV

Einstellbare Monitorhalterung, zum Anklemmen oder Aufschrauben, inklusive einem USB-Anschluss und zwei Audio-Anschlüssen, Farbe SV Silver

Adjustable monitor mount for clamping or screwing, including a USB port and two audio ports, colour SV Silver
Support de moniteur réglable pour fixer ou dévisser, comprenant un port USB et deux ports audio, couleur SV Silver
Porta monitor regolabile da fissaggio o da avvitamento, comprensivo di una porta USB e due porte audio, colore SV Silver



JO-MM2-BG

Einstellbare Monitorhalterung zum Anklemmen oder Aufschrauben, Farbe BG Black

Adjustable monitor mount for clamping or screwing, colour BG Black
Support de moniteur réglable pour le serrage ou le vissage, couleur BG Black
Porta monitor regolabile per il fissaggio o da avvitamento, colore BG Black



JO-CM1-BG

Flexible Kabelschlange zur Kabelführung vom Tisch zum Boden, Farbe BG Black

Flexible cable snake for cable routing from the table to the floor, colour BG Black
Bobine de câble flexible pour le passage des câbles de la table au sol, couleur BG Black
Bobina flessibile per il passaggio dei cavi dal tavolo al pavimento, colore BG Black

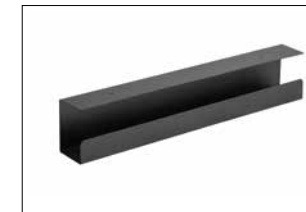

JO-CM2-BG

Kabelkanal bzw. Halterung für eine Steckerleiste, Farbe BG Black

Cable duct or holder for a power strip, colour BG Black
Goulotte ou support de câble pour une barrette de raccordement, couleur BG Black
Canalina per cavi o supporto per ciabatta, colore BG Black



ZU1974

Smart Charge Kit zur Integration in der Tischplatte

Smart Charge Kit to integrate wireless charging in the tabletop
Smart Charge Kit pour intégration dans le plateau de table
Smart Charge Kit per l'integrazione sul piano da lavoro

Belastungsangaben und Gewichte

Load details and weights | Données de charge et poids | Dati di carico e pesi

Tische | Tables | Tables | Tavoli

Artikel <i>Article</i> <i>Article</i> <i>Articolo</i>	Beschreibung <i>Description</i> <i>Description</i> <i>Descrizione</i>	Max. Hubkraft (in kg) ohne Gewicht der Tischplatte <i>Max. lifting force (in kg) without weight of the tabletop</i> <i>Max. force de levage (en kg) sans poids du plateau de table</i> <i>Max. forza di sollevamento (in kg) senza peso del piano da lavoro</i>
JO-EDF1	Tischgestell <i>Desk frame</i> <i>Cadre de table</i> <i>Telaio della scrivania</i>	125
JO-DT	Tischplatte <i>Tabletop</i> <i>Dessus de table</i> <i>Piano scrivania</i>	Breite <i>Width Largeur Larghezza</i>
		Gewicht (in kg) <i>Weight (in kg) Poids (en kg) Peso (in kg)</i>
		120 – 140
140 – 170	~ 15	
170 – 200	~ 18	
		~ 21

Zubehör | Accessories | Accessorires | Accessori

Artikel <i>Article</i> <i>Article</i> <i>Articolo</i>	Beschreibung <i>Description</i> <i>Description</i> <i>Descrizione</i>	Max. Belastung (in kg) <i>Max. load (in kg)</i> <i>Charge max. (en kg)</i> <i>Max. carico (in kg)</i>
JO-CM1	Kabelkanal <i>Cable duct Conduit de câbles Canalina per cavi</i>	5
JO-MM1-SV	Monitorhalterung <i>Monitor mount Support pour moniteur Porta monitor</i>	9
JO-MM2-BG	Monitorhalterung <i>Monitor mount Support pour moniteur Porta monitor</i>	6,5

Just.Office – colours & surfaces

Colours & surfaces | Couleurs & surfaces | Colori & superfici

Oberflächen für Tischgestelle

Surfaces for desk frames | Surfaces pour cadres de table | Superfici per telai di scrivanie



SNG Snow

GR Grey

BG Black

Oberflächen für Tischplatten und Kanten

Surfaces for tabletops and edges | Surfaces pour plateaux de table et bords de la table | Superfici per piani e bordi di scrivanie

Uni Farben – pflegeleichte, matte Oberfläche (19 mm)

Plain colours – easy-care, matt surface (19 mm) | Couleurs unies – surface finition mate facile à entretenir (19 mm) | Colori tinta unita – superficie opaca di facile manutenzione (19 mm)

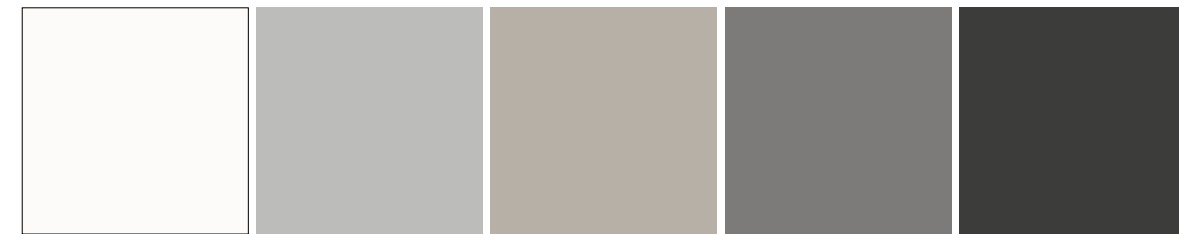

SNG Snow

GR Grey

PE Pebble

GN Granite

BG Black

Holzdekor – strukturiert (12 mm)

Wood decor – textured (12 mm) | Décor en bois – structuré (12 mm) | Decoro in legno – strutturato (12 mm)



LO Light Oak

NO Natural Oak

DP Deep Oak

UC Urban Cherry

Die Farbe der Arbeitsfläche und der Tischkante ist frei wählbar und kann frei kombiniert werden.

The colour of the work surface and the edge of the table is freely selectable and combinable.

La couleur du plan de travail et du bord de la table est librement sélectionnable et peut être combinée librement.

Il colore del piano di lavoro e del bordo di quest'ultimo è liberamente selezionabile e liberamente abbinabile.



Just.Rack

Just.Stand

Just.Mount

MADE IN GERMANY



Just.Rack TV1203ALBG ▶



◀ Just.Stand TV620SP-BG

◀ Just.Mount JM400CSV2

Jetzt einfach online konfigurieren
Simply configure online
www.justbyspectral.de



Filzgleiter und Doppelrollen sind im Lieferumfang enthalten | Felt glides and twin castors are included | Patins en feutre et doubles roulettes inclus dans la livraison | Feltrini e doppie ruote in dotazione

TV-Modelle mit Kabelabdeckung | TV models with cable cover | Modèles TV avec cache-câble | Modelli TV con copricavo

Kratzfeste Glasebenen [R590: 6 mm, TV-Racks: 8 mm] | Scratch-resistant glass shelves [R590: 6 mm, TV-Racks: 8 mm] | Étagères de verre résistant aux rayures [R590 : 6 mm, TV-Racks : 8 mm] | Ripiani in vetro lucido antigraffio [R590: 6 mm, TV-Racks: 8 mm]

Hochwertige Säulen aus geschliffenem Aluminium | High-quality columns made of polished aluminium | Colonne de haute qualité en aluminium poli | Prestigiose colonne in alluminio levigato

Ab Lager lieferbar
Available from stock
Disponibles depuis le stock
Disponibile in stock

Bild Image Immagine	Außenmaße (cm) External dimensions (cm) Dimensions extérieures (cm) Dimensioni est. (in cm)	Artikel Article Articolo	Maße (cm) Dimensions (cm) Dimensions (cm) Dimensioni (cm)
---------------------------	--	--------------------------------	--

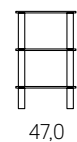
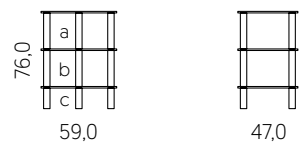

R590ALBG

a	45,0	28,0	40,0
b	45,0	28,0	40,0
c	45,0	16,0	40,0

Inklusive Kabelspirale für geordnetes Kabelmanagement
Incl. cable spiral for orderly cable management
Une spirale de câbles incluse pour une gestion ordonnée des câbles
Include una spirale cavi per una gestione ordinata dei cavi

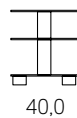
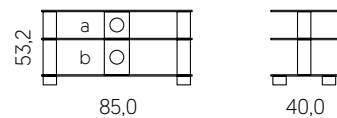

TV8553AL

TV8553ALBG

a	69,0	16,0	40,0
b	69,0	28,0	40,0

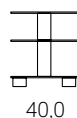
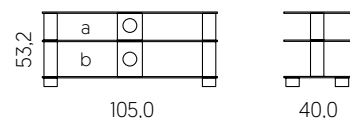

TV1053AL

TV1053ALBG

a	89,0	16,0	40,0
b	89,0	28,0	40,0

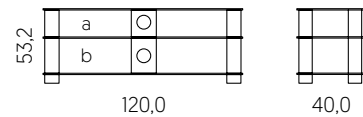

TV1203AL

TV1203ALBG

a	90,0	16,0	40,0
b	90,0	28,0	40,0

Just.Rack – colours & surfaces

Colours & surfaces | Couleurs & surfaces | Colori & superfici

R590:
Glasebenen Black (BG)
Rohre Aluminium
Glass shelves Black (BG)
Columns Aluminium
Étagères en verre Black (BG)
Colonnes Aluminium
Ripiani in vetro Black (BG)
Tubi in alluminio

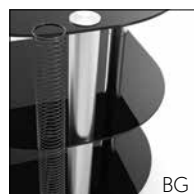

TV-Racks:
Glasebenen Klarglas (KG) oder Black (BG)
Rohre Aluminium
Glass shelves Clear glass (KG) or Black (BG)
Columns Aluminium
Étagères en verre Clair (KG) ou Black (BG)
Colonnes Aluminium
Ripiani in vetro Trasparente (KG) o Black (BG)
Tubi in alluminio

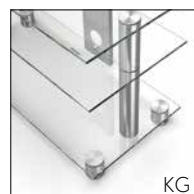

Platzsparender TV-Stand mit kratzfestem Glasboden [12 mm]. Die Kabelführung erfolgt unsichtbar im Standrohr.
Space-saving TV stand with scratch-resistant glass base [12 mm]. Cables are routed out-of-sight through the tubular column.

Meuble TV compact avec base en verre résistant aux rayures [12 mm]. Les câbles sont discrètement passés à travers la colonne tubulaire.

Mobile porta TV salvaspazio con base in vetro antigraffio [12 mm]. I cavi vengono inseriti in modo che non si vedano, attraverso la colonna tubolare.

Ab Lager lieferbar
Available from stock
Disponibles depuis le stock
Disponibile in stock

Bild Image Immagine	Außenmaße (cm) External dimensions (cm) Dimensions extérieures (cm) Dimensioni est. (in cm)	Artikel Article Articolo	Maße (cm) Dimensions (cm) Dimensions (cm) Dimensioni (cm)	VESA Adapter VESA adapter Adaptateur VESA Adattatore VESA	Ablage Soundbar Soundbar shelf Support pour barre de son Adattatore soundbar	Ablagefläche Sockel Storage space base Surface d'appui, base Superficie della base
---------------------------	--	--------------------------------	--	--	--	---

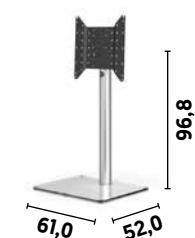

TV600-KG
TV600-BG

200x200 – 400x400	–	61,0x36,0
-------------------	---	-----------

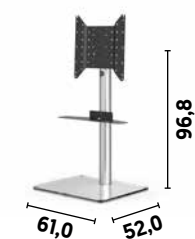

TV610SP-KG
TV610SP-BG

200x200 – 400x400	54,8x14,0	61,0x36,0
-------------------	-----------	-----------

Inkl. Soundbar Ablage Universal, geeignet für Sonos Beam, Bose Solo 5, Bose Soundbar 500 und 700 und weitere Soundbar-Modelle

Incl. soundbar tray universal, suitable for Sonos Beam, Bose Solo 5, Bose Soundbar 500 and 700 and other soundbar models.

Support universel pour barre de son inclus, convient pour Sonos Beam, Bose Solo 5, Bose Soundbar 500 et 700 et d'autres modèles de barres de son

Incl. adattatore soundbar universale, adatto per Sonos Beam, Bose Solo 5, Bose Soundbar 500 e 700 e altri modelli di soundbar

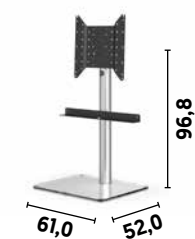

TV620SP-KG
TV620SP-BG

200x200 – 400x400	65,0x6,7	61,0x36,0
-------------------	----------	-----------

Inkl. Soundbar Ablage für Sonos Arc

Incl. soundbar tray for Sonos Arc

Support de barre de son pour Sonos Arc inclus

Incl. adattatore soundbar per Sonos Arc

Just.Stand – colours & surfaces

Colours & surfaces | Couleurs & surfaces | Colori & superfici

Sockelplatte Klarglas (KG) oder Black (BG)

Rohre Aluminium

Base Clear glass (KG) or Black (BG)
Columns Aluminium

Base en verre Clair (KG) ou Black (BG)
Colonnes Aluminium

Basamento in vetro Trasparente (KG) o Black (BG)
Tubi in alluminio



Belastungsangaben & Technische Daten

Load & technical data | Charge et caractéristiques techniques | Indicazioni di carico & dati tecnici



Just.Mount Small / Medium

Mit unseren bewährten TV-Halterungen ist die Befestigung des Fernsehers ein Kinderspiel: einfach zu installieren, rundum sicher und zudem superflach an der Wand. Ob neigbar, schwenkbar, drehbar oder alles zusammen.

With our proven TV mounts, mounting the TV is a breeze: Easy to install, secure all around and also super flat on the wall. Whether tiltable, swiveling, rotatable or all three.

Avec nos supports TV reconnus, la fixation du téléviseur est un jeu d'enfant : facile à installer, sécurisé de tous les côtés et en plus super plat sur le mur. Qu'ils soient inclinables, pivotants, rotatifs ou tout à la fois.

Con le nostre collaudate staffe per TV, fissare il televisore è un gioco da ragazzi: Facile da installare, sicuro su tutto il perimetro e anche super piatto sulla parete. Inclinabili, girevoli, ruotabili o tutti insieme.

Bild Image Immagine	Artikel Article Articolo	Beschreibung Description Descrizione	
	JM200CV2	TV-Diagonale TV diagonal Diagonale du téléviseur Diagonale TV VESA Neigung Tilt Inclinaison Inclinazione Schwenken Swivel Pivotement Panning Drehung Rotation Rotazione Max. Belastung Max. load Charge max. Portata max. Wandabstand Wall distance Distance au mur Distanza dalla parete	14–32" (35–81cm) 75x75–200x200 +3°/-10° +90°/-90° +3°/-3° 12 kg 50–197mm
	JM400FV2	TV-Diagonale TV diagonal Diagonale du téléviseur Diagonale TV VESA Neigung Tilt Inclinaison Inclinazione Schwenken Swivel Pivotement Panning Drehung Rotation Rotazione Max. Belastung Max. load Charge max. Portata max. Wandabstand Wall distance Distance au mur Distanza dalla parete	26–55" (66–139cm) 100x100–400x400 – – – 35 kg 28mm
	JM400SF	TV-Diagonale TV diagonal Diagonale du téléviseur Diagonale TV VESA Neigung Tilt Inclinaison Inclinazione Schwenken Swivel Pivotement Panning Drehung Rotation Rotazione Max. Belastung Max. load Charge max. Portata max. Wandabstand Wall distance Distance au mur Distanza dalla parete	26–55" (66–139cm) 75x75–400x400 – – – 30 kg 18mm
	JM400ST	TV-Diagonale TV diagonal Diagonale du téléviseur Diagonale TV VESA Neigung Tilt Inclinaison Inclinazione Schwenken Swivel Pivotement Panning Drehung Rotation Rotazione Max. Belastung Max. load Charge max. Portata max. Wandabstand Wall distance Distance au mur Distanza dalla parete	26–55" (66–139cm) 75x75–400x400 15° – – 30 kg 20mm
	JM400CSV2	TV-Diagonale TV diagonal Diagonale du téléviseur Diagonale TV VESA Neigung Tilt Inclinaison Inclinazione Schwenken Swivel Pivotement Panning Drehung Rotation Rotazione Max. Belastung Max. load Charge max. Portata max. Wandabstand Wall distance Distance au mur Distanza dalla parete	26–55" (66–139cm) 100x100–400x400 +8°/-5° 180° +4°/-4° 31,8 kg 55–500mm

Just.Mount Large

Alle TV-Halterungen sind sofort ab Lager lieferbar.

All TV mounts are immediately available from stock.

Tous les supports TV sont immédiatement disponibles depuis le stock.

Tutti i staffe TV sono immediatamente disponibili a scorte.

Bild Image Immagine	Artikel Article Articolo	Beschreibung Description Descrizione	
	JM600SF	TV-Diagonale TV diagonal Diagonale du téléviseur Diagonale TV VESA Neigung Tilt Inclinaison Inclinazione Schwenken Swivel Pivotement Panning Drehung Rotation Rotazione Max. Belastung Max. load Charge max. Portata max. Wandabstand Wall distance Distance au mur Distanza dalla parete	40–75" (101–190cm) 75x75–600x400 – – – 30 kg 18mm
	JM600ST	TV-Diagonale TV diagonal Diagonale du téléviseur Diagonale TV VESA Neigung Tilt Inclinaison Inclinazione Schwenken Swivel Pivotement Panning Drehung Rotation Rotazione Max. Belastung Max. load Charge max. Portata max. Wandabstand Wall distance Distance au mur Distanza dalla parete	40–75" (101–190cm) 75x75–600x400 15° – – 30 kg 24mm
	JM600CSV2	TV-Diagonale TV diagonal Diagonale du téléviseur Diagonale TV VESA Neigung Tilt Inclinaison Inclinazione Schwenken Swivel Pivotement Panning Drehung Rotation Rotazione Max. Belastung Max. load Charge max. Portata max. Wandabstand Wall distance Distance au mur Distanza dalla parete	32–75" (81–190cm) 100x100–400x400 +8°/-5° 160° +4°/-4° 45,5 kg 48–490mm
	JM645CS	TV-Diagonale TV diagonal Diagonale du téléviseur Diagonale TV VESA Neigung Tilt Inclinaison Inclinazione Schwenken Swivel Pivotement Panning Drehung Rotation Rotazione Max. Belastung Max. load Charge max. Portata max. Wandabstand Wall distance Distance au mur Distanza dalla parete	37–70" (94–177cm) 200x200–600x400 +2°/-15° +60°/-60° +3°/-3° 45 kg 49–482mm
	JM600E	TV-Diagonale TV diagonal Diagonale du téléviseur Diagonale TV VESA Neigung Tilt Inclinaison Inclinazione Schwenken Swivel Pivotement Panning Drehung Rotation Rotazione Max. Belastung Max. load Charge max. Portata max. Wandabstand Wall distance Distance au mur Distanza dalla parete	37–70" (94–177cm) 200x200–600x400 +8°/-12° 180° +3°/-3° 40 kg 45–680mm
	JM800C	TV-Diagonale TV diagonal Diagonale du téléviseur Diagonale TV VESA Neigung Tilt Inclinaison Inclinazione Schwenken Swivel Pivotement Panning Drehung Rotation Rotazione Max. Belastung Max. load Charge max. Portata max. Wandabstand Wall distance Distance au mur Distanza dalla parete	43–100" (109–254cm) 300x200–800x600 +2°/-15° +90°/-90° +3°/-3° 70 kg 70–800mm

Belastungsangaben & Technische Daten

Load & technical data | Charge et caractéristiques techniques | Indicazioni di carico & dati tecnici

	Max. Gesamtbelastung (in kg) <i>Max. total load (in kg) Charge totale max. (en kg) Portata max complessiva (in kg)</i>	Max. Belastung (in kg) <i>Max. load (in kg) Charge max. (en kg) Portata max (in kg)</i>										
	bodenstehend * <i>floor standing * au sol *</i>	wandhängend * <i>wall mounted * suspendus au mur *</i>	Deckplatte <i>Top plate Plateau supérieur Top</i>	Deckplatte TV-Lift <i>Top plate TV lift Plateau supérieur TV lift Top del TV-Lift</i>	Fachboden Glas <i>Glass shelf Étagère en verre Ripiano in vetro</i>	Fachboden Holz <i>Wooden shelf Étagère en bois Ripiano in legno</i>	Sockelplatte TV Stand <i>Base plate TV stand Base TV stand Plastra di base TV stand</i>	Schublade <i>Drawer Tiroir Cassetto</i>	TV-Halterung <i>TV mount Support TV Supporto TV</i>	TV-Lift <i>TV lift TV lift TV lift</i>	Ablage Soundbar <i>Soundbar shelf Support pour barre de son Adattatore soundbar</i>	Mediamount <i>Media mount Support média Adattatore media</i>
Alpha	60	50	45		15				40		15	5
Bravo	60	50	45		15				40		15	5
Charlie	60	60	25			15		20				
Juliet	60	60	25			15		20				
Lima	60		45		15			20	40		8	5
Basic	60		40						40		8	5
Lift	60		25	0		15		20		40		
Delta		40	40		15	30						
Tango JST9025	15		15									
Tango JST9040	30		30									
Just.Stand	40						20		40		8	
Rack R590	80		40		40							
TV Racks	50		40		20							

* Exklusive Belastung der TV-Halterung | * Does not include load from TV mount | * Charge du support TV non comprise |
* Esclusa portata del supporto TV

Hinweis zu Glasoberflächen:

Glas ist ein Produkt aus natürlichen Rohstoffen und unterliegt produktionstechnischen Schwankungen. Abhängig von der Eigenfarbe des Glases, Glasstärke und den Lichtverhältnissen kann es Farbunterschiede zwischen unterschiedlichen Glasoberflächen geben.

Ebenso kann es Abweichungen von Glasmustern im Fachhandel und dem fertigen Möbel geben. Bei Nachlieferungen von Glasoberflächen sind produktions- und chargenabhängige Farbunterschiede möglich und stellen keinen Reklamationsgrund dar.

Note on glass surfaces:

Glass is a product made from natural raw materials and is subject to variations in production technology. Depending on the inherent colour of the glass, glass thickness and lighting conditions, there may be colour differences between different glass surfaces.

Likewise, there may be deviations between glass samples in the specialized trade and the finished furniture. In the case of subsequent deliveries of glass surfaces, production- and batch-dependent colour differences are possible and do not constitute grounds for complaint.

Remarque sur les surfaces en verre :

Le verre étant un produit issu de matières premières naturelles, il est soumis à des variations techniques dues à sa production. En fonction de la couleur et de l'épaisseur du verre et des conditions d'éclairage, des différences de couleur entre plusieurs surfaces en verre peuvent survenir. De même que peuvent apparaître des différences entre les échantillons de verre présentés dans les magasins spécialisés et le meuble fini. Des différences de couleur sont donc possibles en fonction de la production et des lots lors de livraisons subséquentes de surfaces en verre. Ces différences ne constituent pas un motif de réclamation.

Nota sulle superfici in vetro:

Il vetro è un prodotto realizzato con materie prime naturali ed è soggetto a variazioni di produzione. A seconda del colore naturale del vetro, del suo spessore e delle condizioni di illuminazione, possono esserci differenze di colore tra le diverse superfici di vetro. Ci possono essere delle differenze anche tra i campioni di vetro venduti dai rivenditori specializzati e quelli dei mobili finiti. Nel caso di consegne successive di superfici in vetro, potrebbero verificarsi variazioni di colore dipendenti dalla produzione e dal lotto, che non costituiranno motivo di reclamo.

Hinweis zu Stoffen:

Stoffe unterliegen produktionstechnischen Schwankungen. Deshalb kann es Farbunterschiede zwischen unterschiedlichen stoffbezogenen Bauteilen geben. Ebenso kann es Abweichungen von Stoffmustern im Fachhandel und dem fertigen Möbel geben. Bei Nachlieferungen von stoffbezogenen Bauteilen sind produktions- und chargenabhängige Farbunterschiede möglich und stellen keinen Reklamationsgrund dar.

Note on fabrics:

Fabrics are subject to production variations. Therefore, there may be colour differences between different fabric-related components. Likewise, there may be deviations between fabric samples in the specialist trade and the finished furniture. In the case of subsequent deliveries of fabric-related components, production- and batch-dependent colour differences are possible and do not constitute grounds for complaint.

Remarque sur les tissus :

Les tissus sont soumis à des variations techniques de production. C'est pourquoi il peut y avoir des différences de couleur entre plusieurs éléments recouverts de tissu. De même que peuvent apparaître des différences dans les échantillons de tissus présentés dans les magasins spécialisés et le meuble fini. Des différences de couleur sont donc possibles en fonction de la production et des lots lors de livraisons subséquentes d'éléments en tissus. Ces différences ne constituent pas un motif de réclamation.

Nota sui tessuti:

I tessuti sono soggetti a variazioni tecnico-produttive. Pertanto, possono esserci differenze di colore tra i diversi componenti rivestiti in tessuto. Ci possono essere delle differenze anche tra i campioni di tessuto venduti dai rivenditori specializzati e quelli dei mobili finiti. Nel caso di consegne successive di componenti rivestiti in tessuto, potrebbero verificarsi variazioni di colore dipendenti dalla produzione e dal lotto, che non costituiranno motivo di reclamo.

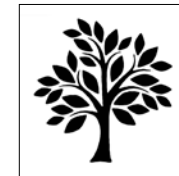

Alle Holzplattenwerkstoffe sind aus nachhaltiger Forstwirtschaft und in der Wohnumwelt gesundheitlich unbedenklich.

All wood panel materials are from sustainable forestry and are safe in the harmless to health in the harmless in the living environment.

Tous les matériaux des panneaux en bois sont issus de la sylviculture durable et ne présentent aucun risque pour la santé dans l'environnement domestique.

Tutti i materiali dei pannelli in legno provengono da fonti sostenibili forestale e sono sicuri salute nell'ambiente di vita. innocuo nell'ambiente di vita.

Bose, Bose Solo 5, Soundbar 500 and Soundbar 700 are registered trademarks owned by Bose Corporation
Sonos, Sonos Arc and Sonos Beam are registered trademarks owned by Sonos Inc.

Technische Änderungen, druckbedingte Farbabweichungen und Irrtümer vorbehalten.

Subject to technical changes, and error. Colours of printed images may not fully correspond to those of physical product.

Sous réserve de modifications techniques, de divergences de couleurs dues à l'impression et d'erreurs.

Salvo modifiche tecniche, variazioni dei colori dovute alla tecnica di stampa ed errori.

Made in Germany

Impressum

Publication details | Mentions légales | Informazioni editoriali



Spectral Audio Möbel GmbH
Robert-Bosch-Straße 1–5
74385 Pleidelsheim
Germany

Tel. +49 7144 88418-80
Fax +49 7144 88418-40
www.justbyspectral.de
info@spectral.eu

Spectral Switzerland
Tel. +41 44 940 4444
schweiz@spectral.eu

Spectral Austria
Tel. +43 7205 14446
austria@spectral.eu

Service commercial France
Tel. +33 5 3352 3423
order@spectral.eu

Sales Office Italia
Tel. +39 02 829 59 896
order@spectral.eu

Spectral International Showroom
Nobelstraat 29
3846 CE Harderwijk
The Netherlands
www.spectral.nl

© 2024 Spectral Audio Möbel GmbH

Stand: Mai 2024

Publication date: May 2024 | Date : mai 2024 | Aggiornato a: Maggio 2024



Jetzt einfach online
konfigurieren
Simply configure online
www.justbyspectral.de

Made in Germany



Jetzt einfach online
konfigurieren
Simply configure online

www.justbyspectral.de

MADE IN GERMANY